



Optimal Solutions for the Future

DNM series



**Global standard
vertical machining
center**

DNM series

DNM 4500

DNM 5700

DNM 6700

ver. EN 160920 SU

Basic Information

Basic Structure
Cutting
Performance

Detailed Information

Options
Applications
Diagrams
Specifications

Customer Support Service



DNM series

Building on the history of the well proven and successful DNM and DNM II series, the new version DNM series boasts even greater reliability and performance. In addition, the new series includes grease lubrication to the roller guideways for more environmental-friendliness. The design concepts of the DNM4500, DNM5700 and DNM6700 are high speed, high rigidity and suitability for universal applications. Standard features are the largest machining space in its class, direct coupled spindle, roller guideways and thermal error compensation to provide optimum precision.

Contents

02 Product Overview

Basic Information

04 Basic Structure

07 Cutting Performance

Detailed Information

08 Standard / Optional Specifications

10 Applications

12 Diagrams

17 Machine / CNC Specifications

22 Customer Support Service



A highly versatile vertical machining center offering the largest machining space in its class

- While requiring the same installation floor space as the previous model, the new DNM series provides a larger table with increased Y axis travel and maximum table load.

Standard Direct-Coupled Spindle for Higher Productivity

- The direct coupled spindle reduces vibration and noise, thereby improving the machines performance and environmental-friendliness compared to belt drive type.
- Higher productivity is achieved by reducing tool change time and improving all axes feed system acc/dec times.

An environmental-friendly machine designed for stable and easy operation

- Thermal error compensation function fitted as standard optimizes machine accuracy by reducing the effects of heat build-up during extended periods of operation.
- The EOP function can be checked in the pop-up window on the NC main screen for convenient machine operation.
- Grease lubrication for axis roller guideways is a standard feature and reduces contamination of the operator's environment.



Basic structure

Designed as a highly stable, rigid structure, the new DNM series offers a wide line-up from 400 to 670 mm in the Y axis, enabling the user to handle a wider range of workpieces.

Travel distance (X x Y x Z axis)

DNM 4500

800x450x510mm (31.5 x 17.7 x 20.1 inch)
(Expanded by 8% compare to previous model)

DNM 5700

1050x570x510mm (41.3 x 22.4 x 20.1 inch)
(Expanded by 8% compare to previous model)

DNM 6700

1300x670x625mm
(51.2 x 26.4 x 24.6 inch)
(Expanded by 2% compare to previous model)

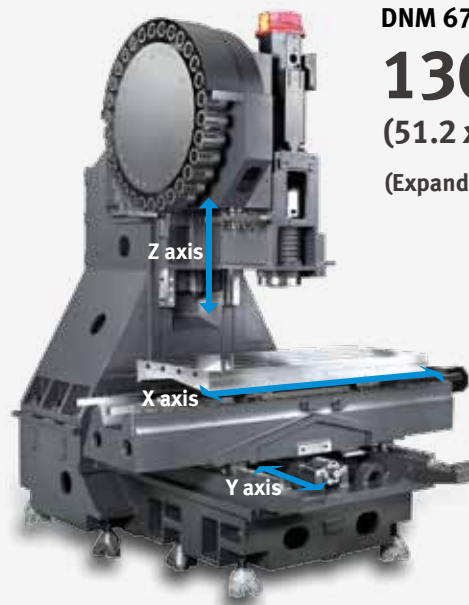

Axis system

Environmentally friendly grease lubrication is adopted as standard for all the axis feed system, and roller-type LM Guides are provided to enhance the rigidity.

Rapid traverse rate

X axis

36m/min
(1417.3 ipm)

Y axis

36m/min
(1417.3 ipm)

Z axis

30m/min
(1181.1 ipm)

Improving all axes feed system acc/dec times by up to 50% compare to previous model.



Grease lubrication for all axes is a standard feature.

Roller-type LM Guides are provided as a standard feature.

Table

Increased table size and maximum load capacity are included to offer maximum workpiece capacity even in the same floor space as previous model.

Wide machining area

Max weight on Table

DNM 4500
600kg (1322.8 lb)

DNM 5700
1000kg
(2204.6 lb)

DNM 6700
1300kg (2866.0 lb)

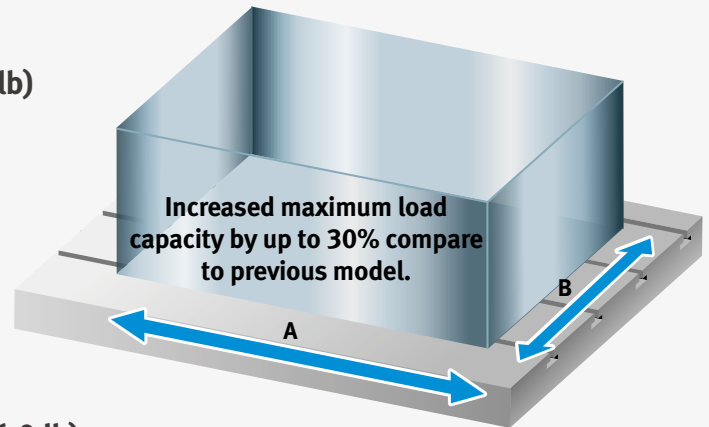

Table size (A x B)

DNM 4500
1000 x 450mm
(39.4 x 17.7 inch)

Expanded by 12%
compare to previous model

DNM 5700
1300 x 570mm
(51.2 x 21.3 inch)

Expanded by 14%
compare to previous model

DNM 6700
1500 x 670mm
(59.1 x 26.4 inch)

Expanded by 15%
compare to previous model

Spindle

Direct-coupled type spindles have been adopted as a standard feature to further reduce vibration and noise while enhancing productivity, work environment and machining accuracy.



Max. spindle speed

8000r/min

12000r/min option

Max. spindle motor power

18.5kW (24.8 Hp)

Max. spindle motor torque

118N·m (86.9 lbf-ft)

(8000 r/min std., 12000 r/min spindle torque)

286N·m (206.7 lbf-ft) option

(8000 r/min high torque version)

Basic Information

- Basic Structure
- Cutting
- Performance

Detailed Information

- Options
- Applications
- Diagrams
- Specifications

Customer Support Service

Tool change system

Tool change time has been optimized to reduce non cutting time. The highly-reliable tool magazine can accommodate up to 30 tools as standard.

Automatic tool change arm



Tool to Tool time

Previous model	1.3s	Reduced by 7.7%
New DNM series	1.2s	

Chip to Chip* time

Previous model	3.7s	Reduced by 13.5%
New DNM series	3.2s	

* The Chip-to-Chip time has been tested in accordance with Doosan's strict testing conditions, but may vary depending on the user's operating conditions.

Magazine



Tool storage capacity

30ea

40ea option



Machining performance

Cutting performance

The DNM series delivers the best cutting performance in its class to optimize productivity.

Face mill (ø80mm (3.15 inch)) Carbon steel (SM45C)			
Chip removal rate cm ³ /min (inch ³ /min)	Spindle speed r/min	Feedrate mm/min (ipm)	
527 (32.2)	1500	2700 (106.3)	
Face mill (ø80mm (3.15 inch)) Aluminium(AL6061)			
Chip removal rate cm ³ /min (inch ³ /min)	Spindle speed r/min	Feedrate mm/min (ipm)	
1901 (116.0)	1500	5940 (233.9)	
End mill (ø30mm (i.2 inch)) Carbon steel (SM45C)			
Chip removal rate cm ³ /min (inch ³ /min)	Spindle speed r/min	Feedrate mm/min (ipm)	
48 (2.9)	222	107 (4.2)	
U-Drill (ø50mm (2.0 inch)) Carbon steel (SM45C)			
Chip removal rate cm ³ /min (inch ³ /min)	Spindle speed r/min	Feedrate mm/min (ipm)	
501 (30.6)	1500	255 (10.0)	
Tap Carbon steel (SM45C)			
Tap size mm	Spindle speed r/min	Feedrate mm/min (ipm)	
M 36 x P 4.0	221	884 (34.8)	

* The results, indicated in this catalogue are provides as example. They may not be obtained due to differences in cutting conditions and environmental conditions during measurement.

High Productivity

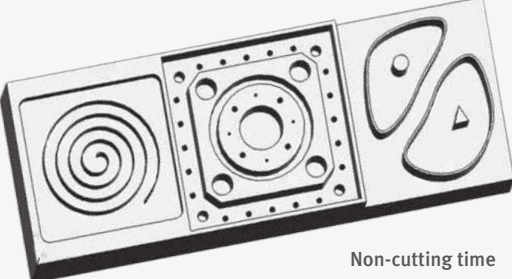

Sample work

Material	Aluminium (AL6061)
Material size	561 x 210 x 30 mm (22.1 x 8.3 x 1.2 inch)
Using tools	18 ea

	Non-cutting time	Cutting time	Run hours
Previous model	14min. 31sec.	37min. 20sec.	51min. 51sec.
	Reduced by 17%		Reduced by 5%
New DNM series	12min. 6sec.	37min. 20sec.	49min. 26sec.

* The results, indicated in this catalogue are provides as example. They may not be obtained due to differences in cutting conditions and environmental conditions during measurement.



Standard / Optional Specifications

● Standard ○ Optional X N/A

Basic Information

Basic Structure
Cutting
Performance

Various optional features are available to satisfy customers' specific machining applications.

Detailed Information

Options
Applications
Diagrams
Specifications

Customer Support Service

NO.	Description	Features	DNM 4500	DNM 5700	DNM 6700			
1	Spindle	8000 r/min (Unit: kW(Hp), N·m(lbf·ft))	18.5(24.8)/11(14.8), 117.8(86.9)_FANUC		●	●	X	
2			18.5(24.8)/15(20.1), 117.8(86.9)_FANUC		X	X	●	
3			15(20.1)/11(14.8), 286(210.9)_FANUC		○	○	○	
4		12000 r/min (Unit: kW(Hp), N·m(lbf·ft))	18.5(24.8)/11(14.8), 117.8(86.9)_FANUC		○	○	○	
5			17(22.8)/10(13.4), 108.6(80.1)_HEIDENHAIN		○	○	X	
6			32(42.9)/15(20.1), 203.7(150.2)_HEIDENHAIN		X	X	○	
7			16.5(22.1)/11(14.8), 141(104.0)_SIEMENS		○	○	X	
8			21.8(29.2)/16.3(21.9), 150.1(110.7)_SIEMENS		X	X	○	
9	Magazine	Tool storage capacity	30 ea		●	●	●	
10			40 ea		○	○	○	
11	Tool shank type	BIG PLUS BT40		●	●	●		
12		BIG PLUS CAT40		○	○	○		
13		BIG PLUS DIN40		○	○	○		
14	Raised column	150 mm (5.9 inch)		○	○	○		
15		200 mm (7.9 inch)		○	○	○		
16		300 mm (11.8 inch)		○	○	○		
17	Coolant	FLOOD	0.15 MPa(21.8 psi), 0.4 kW(0.5 Hp)		●	●	●	
18			0.7 MPa(101.5 psi), 1.8 kW(2.4 Hp)		○	○	○	
19		TSC	None		●	●	●	
20			2 MPa(290.1 psi), 1.5kW(2.0 Hp)		○	○	○	
21			2 MPa(290.1 psi), 4 kW(5.4 Hp)		○	○	○	
22			7 MPa(1015.3 psi), 5.5 kW(7.4 Hp)		○	○	○	
23		FLUSHING		○	○	○		
24		SHOWER (200 L/min (52.8 gal/min))		○	○	○		
25		Chip disposal	Chip conveyor	Chip pan		●	●	●
26				Hinged type (Left/Right/Rear)		○	○	○
27	Magnetic scraper type (Left/Right/Rear)			○	○	○		
28	Screw(AUGER) type (Left/Right)			○	○	○		
29	Chip bucket		○	○	○			
30	Air blower		○	○	○			
31	Air gun		○	○	○			
32	Coolant gun		○	○	○			
33	Mist collector		○	○	○			
34	Precision machining option	Linear scale	X / Y / Z axis		○	○	○	
35		AICC I (40 block)		○	○	○		
36		AICC II (200 block)		○	○	○		
37		SSP (Smooth Surface Package)		○	○	○		
38	Measurement & Automation	Automatic tool measurement	TS27R_RENISHAW		○	○	○	
39			OTS_RENISHAW		○	○	○	
40		Automatic tool breakage detection		○	○	○		
41		Automatic workpiece measurement	OMP60_RENISHAW		○	○	○	
42	Automatic front door with safety device		○	○	○			
43	Others	LED Work light		●	●	●		
44		3 Color signal tower		●	●	●		
45		4th axis auxiliary device interface		○	○	○		
46		Tool load monitoring		●	●	●		
47		EZ Guide i		●	●	●		
48	Automatic power off		○	○	○			

Peripheral equipments

Grease lubrication system

The standard grease lubrication system eliminates the need for an oil skimmer and reduces lubrication costs by about 60% compared to oil lubrication.

Yearly maintenance cost

Max. **60%** ↓



Raised column option 14~16

When the distance between the table top and the spindle nose needs to be extended, for example, accommodate a fixture or rotary axis on the table, solid one-piece raised column can be used to extend the distance.

Height **150mm**
(5.9 inch)
200mm
(7.9 inch)
300mm (11.8 inch)

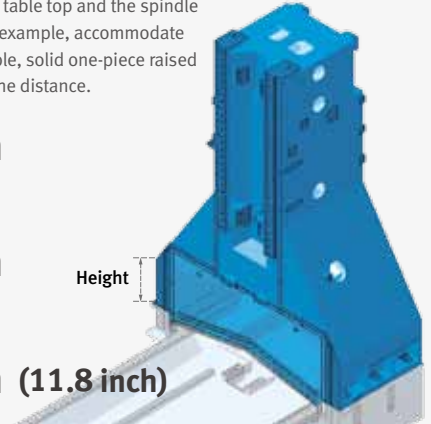

Chip conveyor option 26~28



Hinged belt



Magnetic scraper



Screw (Auger) type

Chip bucket option 29

Capacity **300L** (79.3 gal)



Chip conveyor type	Material	Description
Hinged belt	Steel	Hinged belt chip conveyor, which is most commonly used for steel work [for cleaning chips longer than 30mm(1.2inch)], is available as an option.
Magnetic scraper	Cast Iron	Magnetic scraper type chip conveyor, which is ideal for die-casting work [for cleaning small chips], is available as an option.
Screw (Auger) type	Steel	Screw (Auger) type chip conveyor is suitable for minimizing installation space. About 85% floor space is required to install Screw (Auger) type chip conveyor compare to Hinged belt type.

4th axis auxiliary device interface option 45

Users who wish to set up a rotary axis on the table to increase application flexibility are encouraged to contact Doosan in advance.

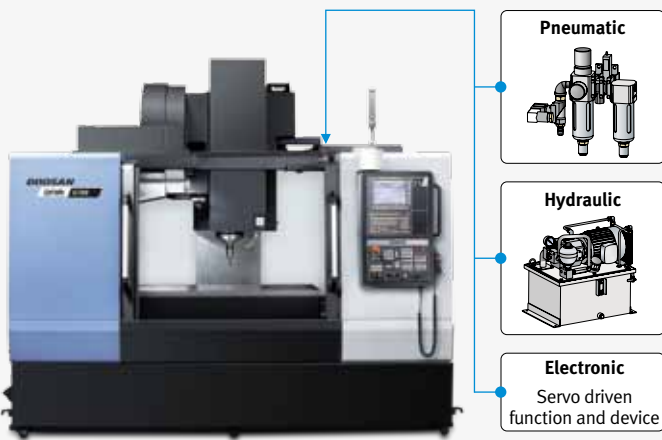

Hydraulic / Pneumatic fixture line option

The user should prepare pipelines for hydraulic/pneumatic fixtures whose detailed specifications should be determined by discussion with Doosan.

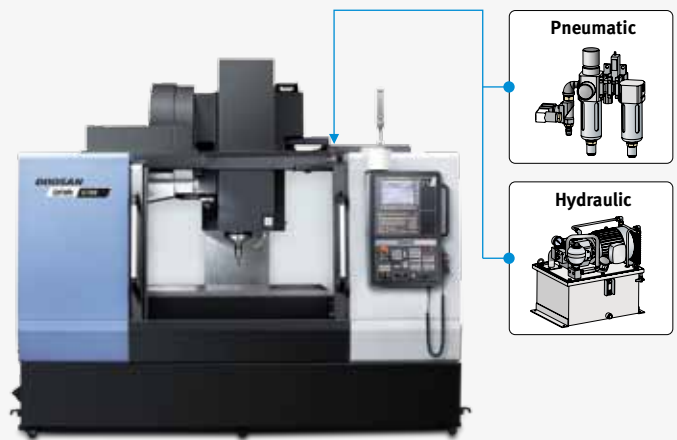

DOOSAN FANUC i

FANUC CNC has been optimized for Doosan's machine tools to maximize productivity.

User-friendly operation panel

The newly-designed operation panel enhances operating convenience by common-design buttons and layout. Just like a PC, the QWERTY type keyboard has been adopted for easier and faster operation.

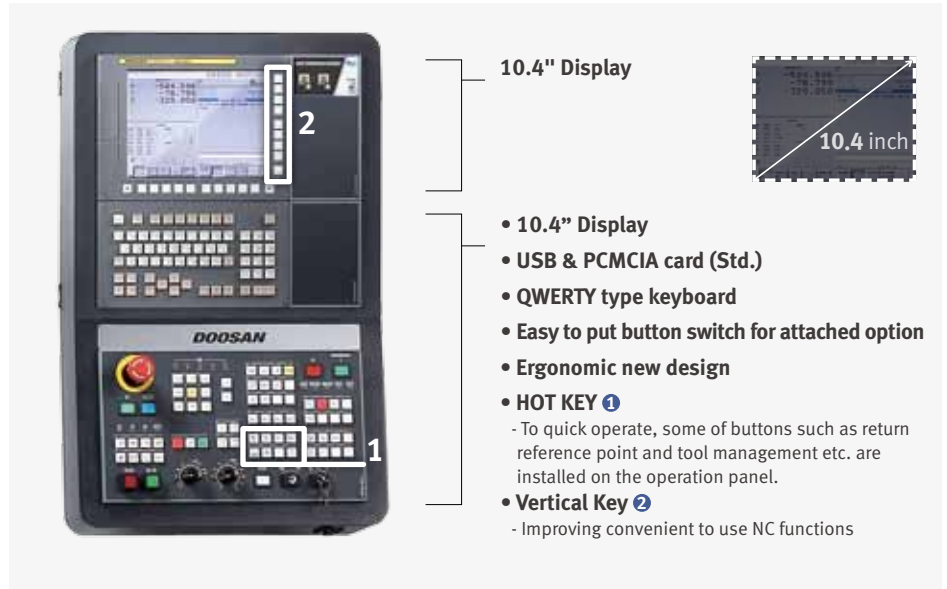

10.4" Display

- 10.4" Display
- USB & PCMCIA card (Std.)
- QWERTY type keyboard
- Easy to put button switch for attached option
- Ergonomic new design
- **HOT KEY ①**
- To quick operate, some of buttons such as return reference point and tool management etc. are installed on the operation panel.
- **Vertical Key ②**
- Improving convenient to use NC functions

Easy Operation Package

The software developed by Doosan's own technology provides numerous functions designed for convenient operation.

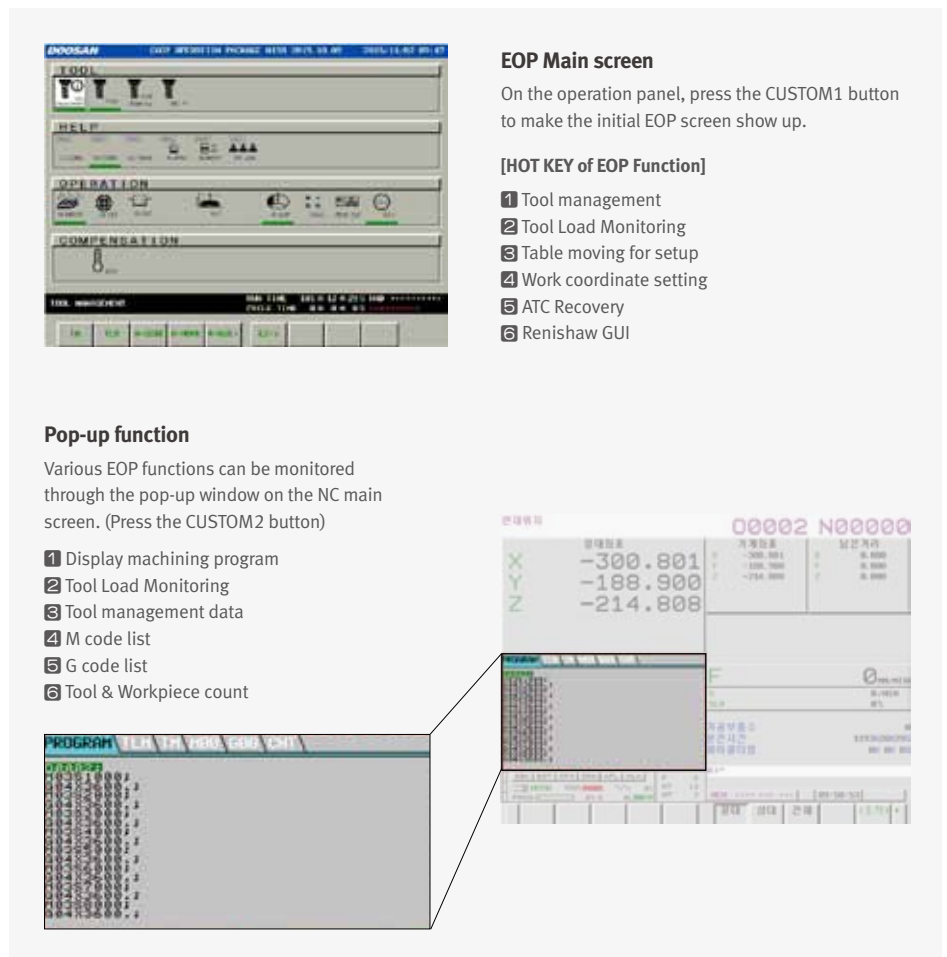

EOP Main screen
On the operation panel, press the CUSTOM1 button to make the initial EOP screen show up.

[HOT KEY of EOP Function]

- ① Tool management
- ② Tool Load Monitoring
- ③ Table moving for setup
- ④ Work coordinate setting
- ⑤ ATC Recovery
- ⑥ Renishaw GUI

Pop-up function
Various EOP functions can be monitored through the pop-up window on the NC main screen. (Press the CUSTOM2 button)

- ① Display machining program
- ② Tool Load Monitoring
- ③ Tool management data
- ④ M code list
- ⑤ G code list
- ⑥ Tool & Workpiece count



Tool management

This function controls information on the tools in the tool magazine pots.



Table moving for setup

Table can be moved to workpiece setup position with simple operation.



Tool load monitoring

During cutting operation, abnormal load caused by wear and tear of the tool is detected and an alarm is triggered to prevent further damage.



Thermal compensation function

A thermal error compensation function is provided as a standard feature to secure stable cutting safe from potentially harmful environmental factors.



ATC recovery

In the event of an error during ATC (automatic tool changer) operation, follow the on-screen instructions for an easy and prompt solution.

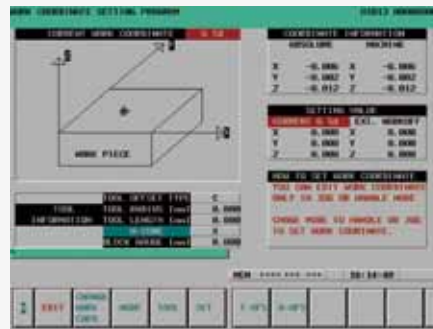

Work coordinate setting

It is easy to configure various work offset settings.



Adaptive Feed Control(AFC)

If tool overload is detected during operation, the feed rate is controlled to prevent the tool from being damaged.



Alarm guidance

It is easy to show detailed information on frequently occurred alarms and recommended actions.

Spindle Power – Torque Diagram

Basic Information

Basic Structure
Cutting
Performance

Detailed Information

Options
Applications
Diagrams
Specifications

Customer Support Service

[FANUC] 8000 r/min

DNM 4500/5700

Max. spindle power: 18.5 kW (24.8 Hp)
Max. spindle torque: 117.8 N·m (86.9 lbf-ft)

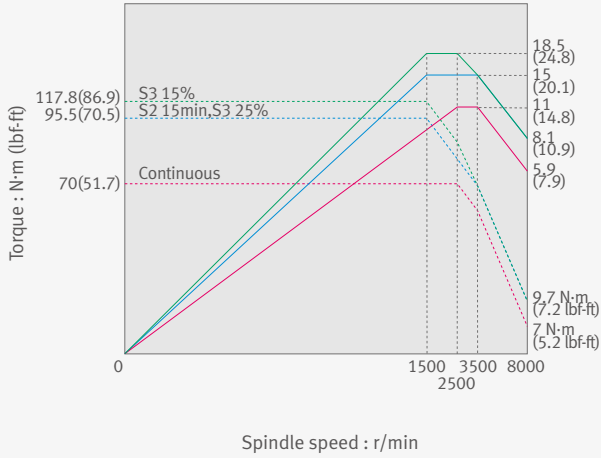

DNM 6700

Max. spindle power: 18.5 kW (24.8 Hp)
Max. spindle torque: 117.8 N·m (86.9 lbf-ft)

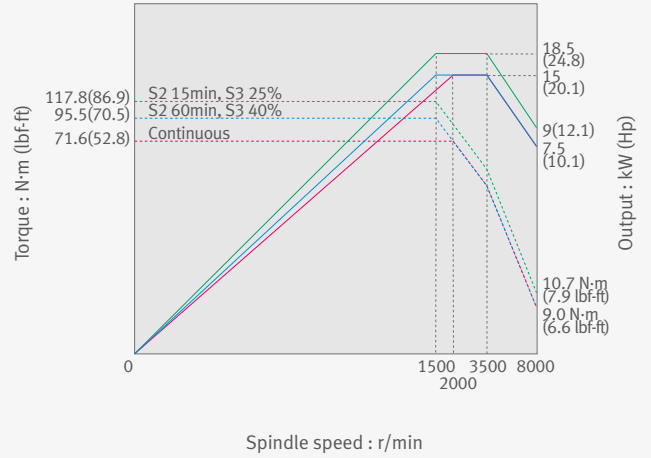

[FANUC] 8000 r/min High Torque option

DNM 4500/5700/6700

Max. spindle power: 15 kW (20.1 Hp)
Max. spindle torque: 286 N·m (211.1 lbf-ft)

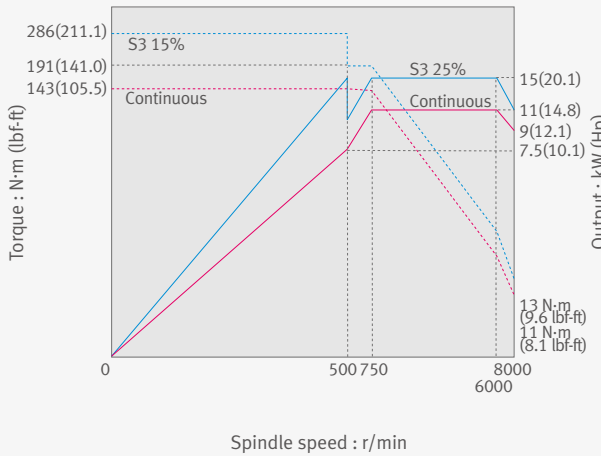

[FANUC] 12000 r/min option

DNM 4500/5700/6700

Max. spindle power: 18.5 kW (24.8 Hp)
Max. spindle torque: 117.8 N·m (86.9 lbf-ft)

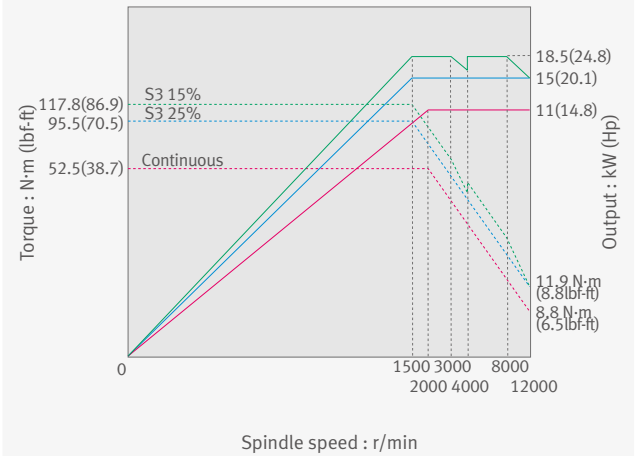

[SIEMENS] 12000 r/min

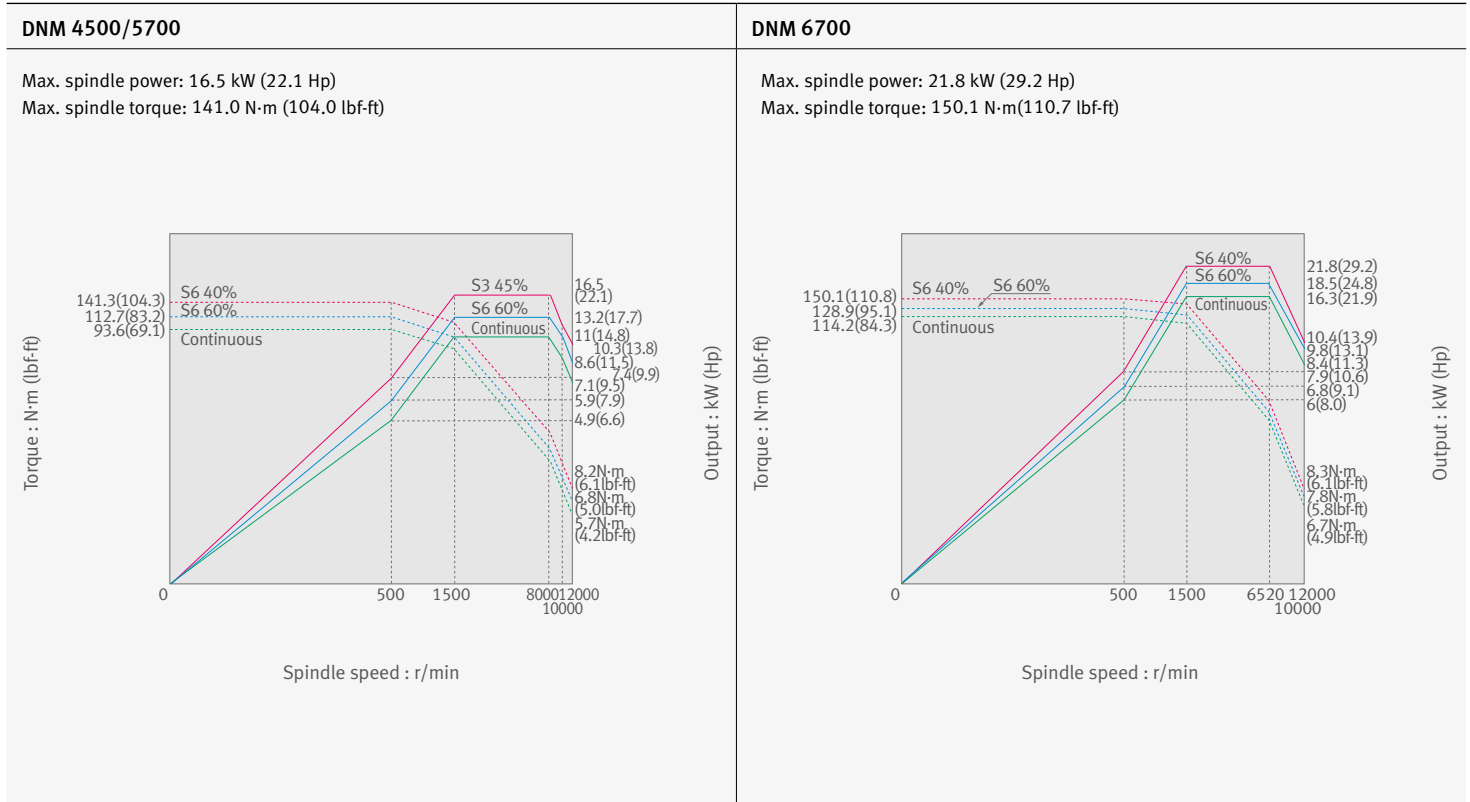

[HEIDENHAIN] 12000 r/min

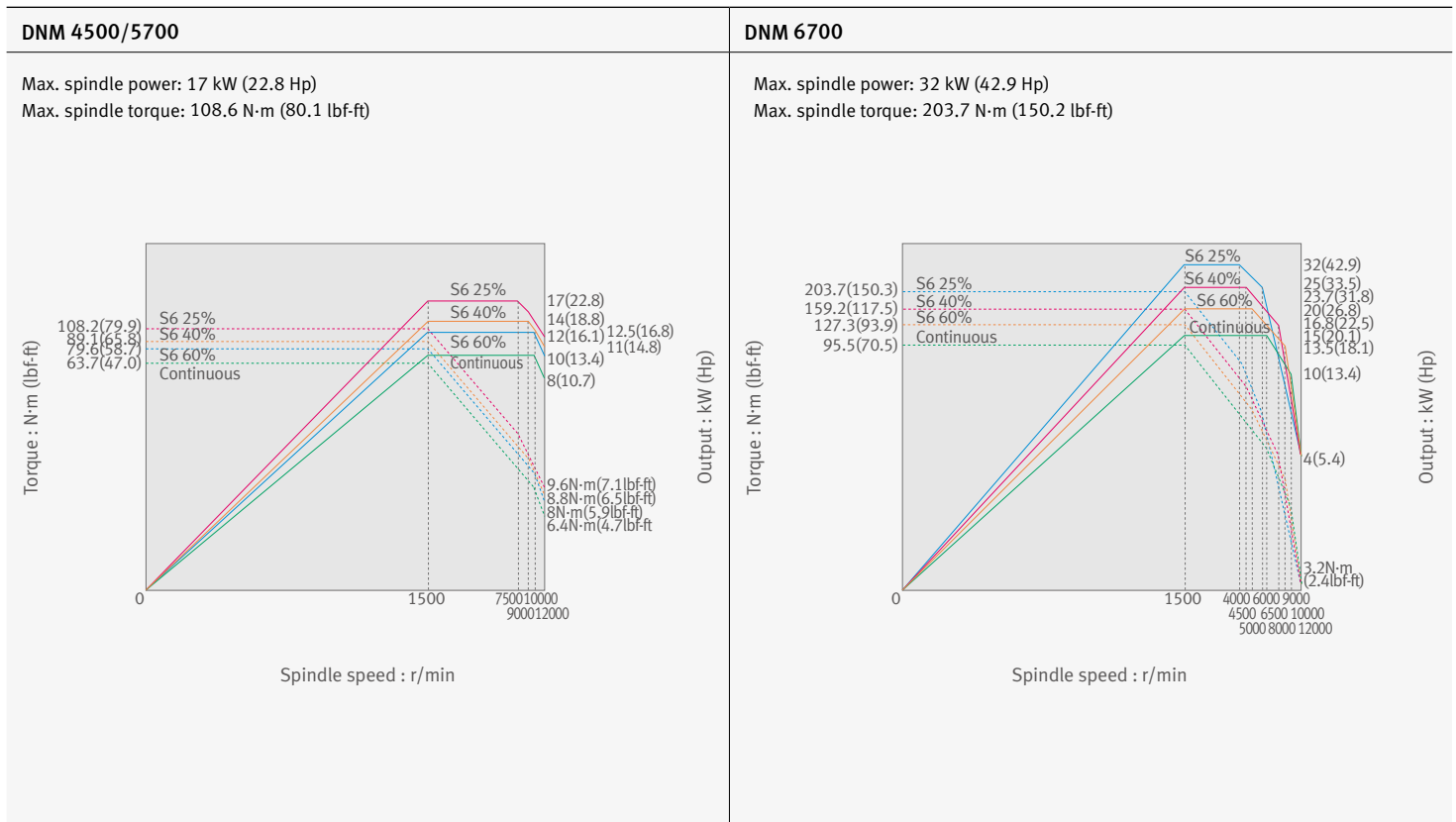

External Dimensions

Basic Information

Basic Structure
Cutting
Performance

DNM series (Left or Right side chip conveyor)

Unit: mm (inch)

Detailed Information

Options
Applications
Diagrams
Specifications

Customer Support Service

Top View

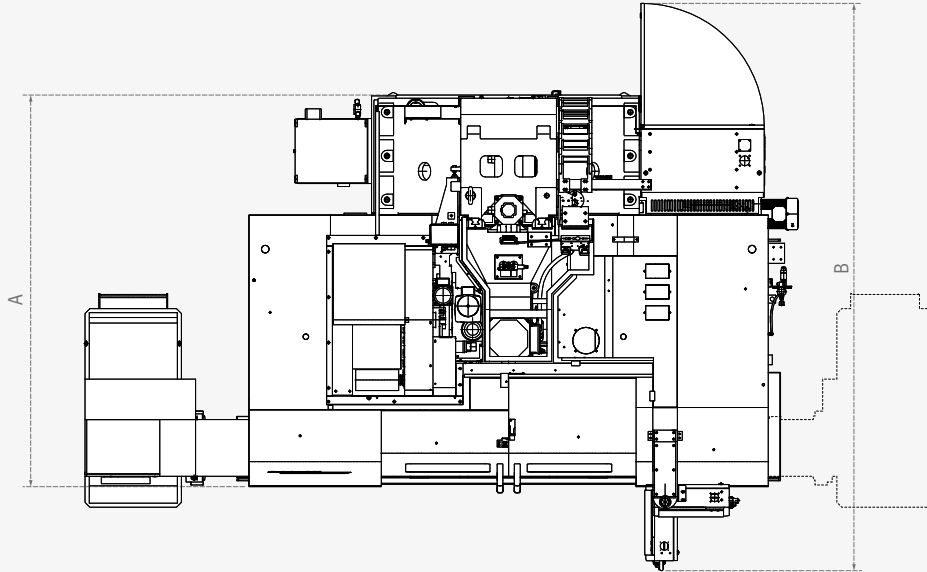

Front View

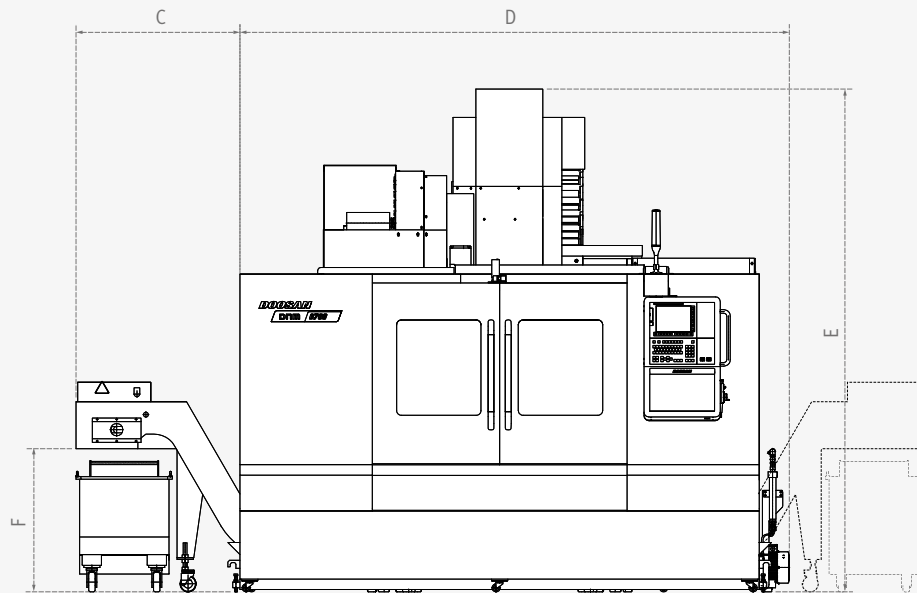

Model	A (Length)	B ¹	C ²	D (Width)	E (Height)	F ³
DNM 4500	1966 (77.4)	3219 (126.7)	1010 (39.8) [414 (16.3)]	2634 (103.7)	2985 (117.5)	883 (34.8) [440 (17.3)]
DNM 5700	2221 (87.4)	3349 (131.9)	1010 (39.8) [398 (15.7)]	3145 (123.8)	2985 (117.5)	883 (34.8) [440 (17.3)]
DNM 6700	2415 (95.1)	3498 (137.7)	1010 (39.8) [378 (14.9)]	3385 (133.3)	3100 (122.0)	883 (34.8) [440 (17.3)]

¹ Max. machine length (including electric cabinet door and operation panel swiveling)

² Additional width to accommodate the side chip conveyor. [] indicates the additional width required to accommodate a screw(auger)type chip conveyor.

³ Height from the floor to the chip outlet. [] indicates the height when a screw(auger) type chip conveyor is installed.

DNM series (Rear side chip conveyor)

Unit: mm (inch)

Top View

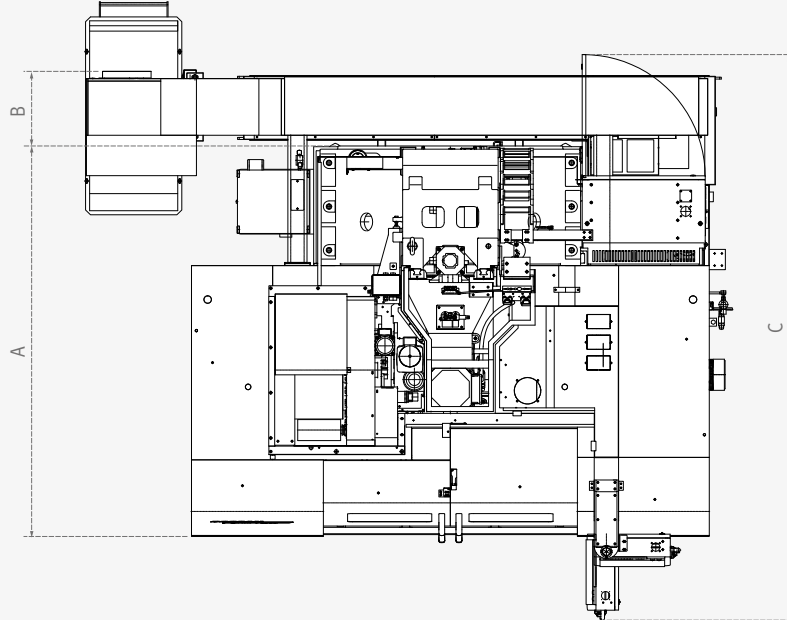

Front View

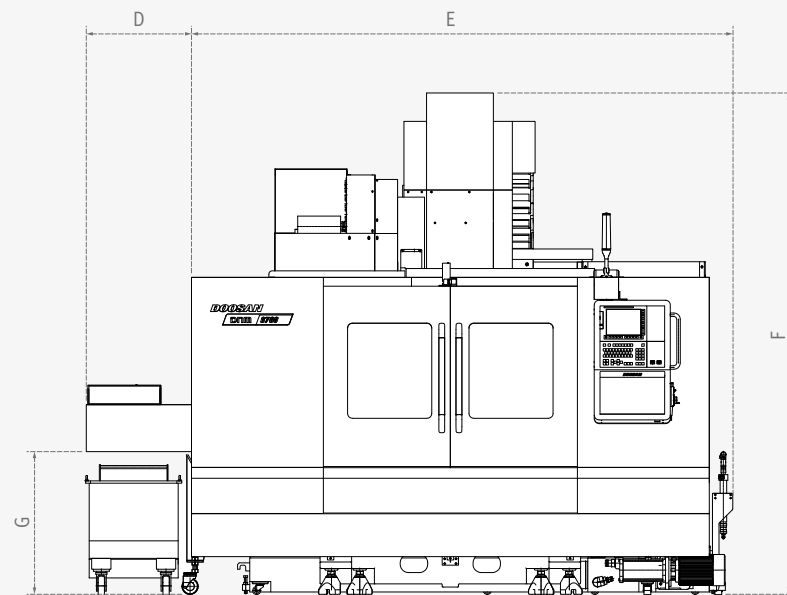

Model	A (Length)	B ¹	C ²	D ³	E (Width)	F (Height)	G ⁴
DNM 4500	1966 (77.4)	458 (18.0)	3219 (126.7)	880 (34.6)	2607 (102.6)	2985 (117.5)	883 (34.8)
DNM 5700	2221 (87.4)	458 (18.0)	3349 (131.9)	650 (25.6)	3105 (122.2)	2985 (117.5)	883 (34.8)
DNM 6700	2415 (95.1)	461 (18.1)	3498 (137.7)	650 (25.6)	3342.5 (131.6)	3100 (122.0)	883 (34.8)

- ¹ Additional length required to accommodate a rear-side chip conveyor.
- ² Max. machine length (including electric cabinet door and operation panel swiveling)
- ³ Additional space required for the machine to accommodate a rear-side chip conveyor.
- ⁴ Height from the floor to the chip outlet.

Table

Basic Information

- Basic Structure
- Cutting
- Performance

Detailed Information

- Options
- Applications
- Diagrams
- Specifications

Customer Support Service

DNM 4500

Unit: mm (inch)

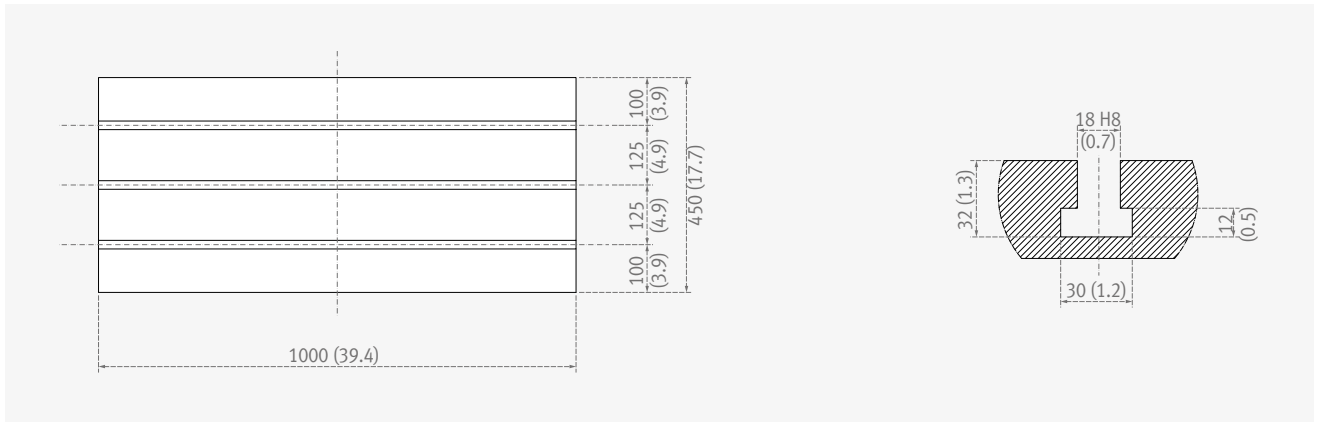

DNM 5700

Unit: mm (inch)

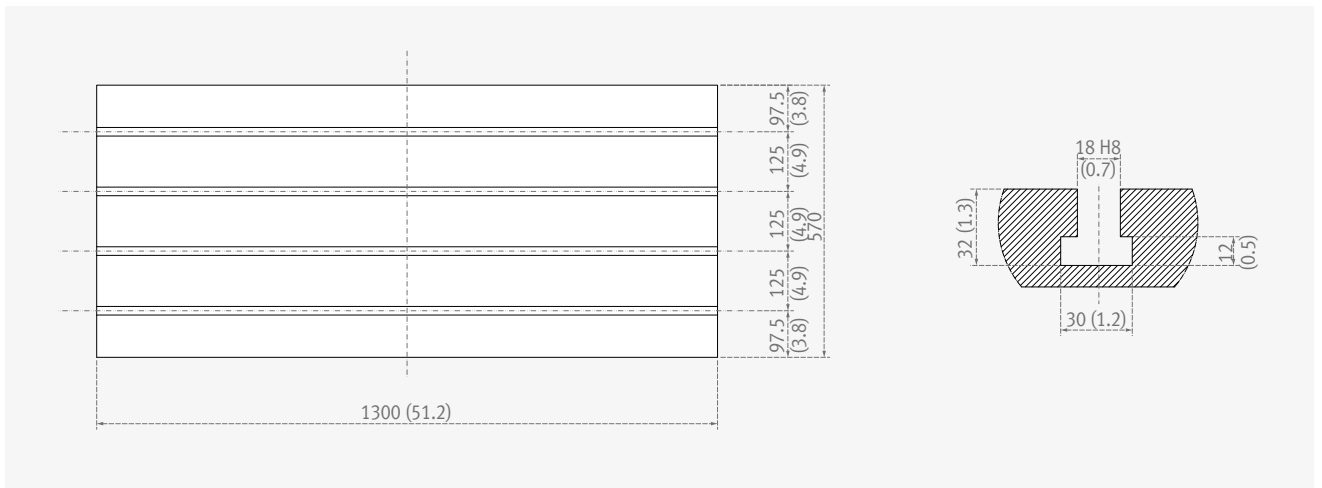

DNM 6700

Unit: mm (inch)

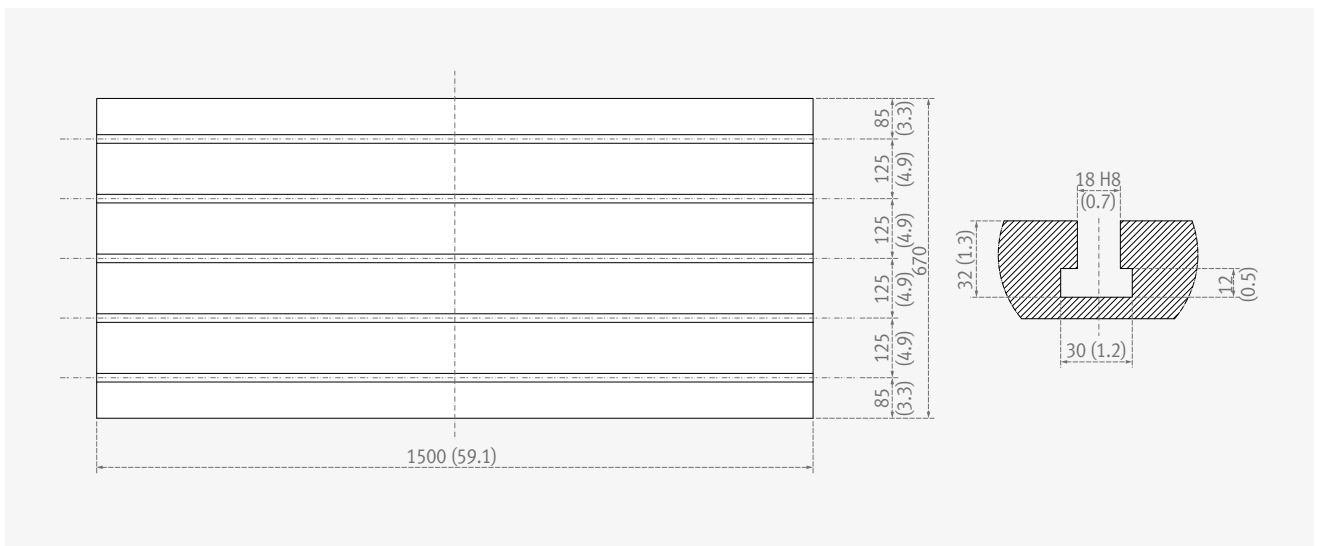

Machine Specifications



Description		Unit	DNM 4500	DNM 5700	DNM 6700	
Travels	Travel distance	X axis	mm (inch)	800 (31.5)	1050 (41.3)	1300 (51.2)
		Y axis	mm (inch)	450 (17.7)	570 (22.4)	670 (26.4)
		Z axis	mm (inch)	510 (20.1)	510 (20.1)	625 (24.6)
	Distance from spindle nose to table top		mm (inch)	150~660 (5.9~26.0)		150~775 (5.9~30.5)
Table	Table size		mm (inch)	1000 x 450 (39.4 x 17.7)	1300 x 570 (51.2 x 22.4)	1500 x 670 (59.1 x 26.4)
	Table loading capacity		kg (lb)	600 (1322.8)	1000 (2204.6)	1300 (2866.0)
	Table surface type		mm (inch)	T-SLOT (3-125(4.9) x 18(0.7)H8)	T-SLOT (4-125(4.9) x 18(0.7)H8)	T-SLOT (5-125(4.9) x 18(0.7)H8)
Spindle	Max. spindle speed		r/min	8000 {12000}		
	Taper		-	ISO #40		
	Spindle power	Fanuc (S3/Cont.)	kW (Hp)	18.5 (24.8) / 11 (14.8) {15 (20.1) / 11 (14.8)*}		18.5 (24.8) / 15 (20.1) {18.5 (24.8) / 11 (14.8)**, 15 (20.1) / 11 (14.8)*}
		Siemens (S6 40%/Cont.)	kW (Hp)	16.5 (22.1) / 11 (14.8)		21.8 (29.2) / 16.3 (21.9)
		Heidenhain (S6 25%/Cont.)	kW (Hp)	17 (22.8) / 10 (13.4)		32 (42.9) / 15 (20.1)
	Max. spindle torque	Fanuc (S3)	N·m (lbf·ft)	117.8 (86.9) {286 (210.9)*}		
		Siemens (S6 40%)	N·m (lbf·ft)	141 (104.0)		150.1 (110.7)
Heidenhain (S6 25%)		N·m (lbf·ft)	108.6 (80.1)		203.7 (150.2)	
Feedrates	Rapid traverse rate	X axis	m/min (ipm)	36 (1417.3)		
		Y axis	m/min (ipm)	36 (1417.3)		
		Z axis	m/min (ipm)	30 (1181.1)		
Automatic Tool Changer	Type of tool shank	Tool shank	-	BT 40 {CAT 40 / DIN 40}		
		Pull stud	-	PS806 {Modified DIN / DIN 69872 #40}		
	Tool storage capa.		ea	30 {40}		
	Max. tool diameter	Continuous	mm (inch)	80 (3.1) {76 (3.0)}		
		Without Adjacent Tools	mm (inch)	125 (4.9)		
	Max. tool length		mm (inch)	300 (11.8)		
	Max. tool weight		kg (lb)	8 (17.6)		
	Tool selection			MEMORY RANDOM		
	Tool change time (Tool-to-tool)		sec	1.2		
Tool change time (Chip-to-chip)		sec	3.2			
Power source	Electric power supply(rated capacity)		kVA	29.6	38.1 {33.0***}	
	Compressed air supply		MPa (psi)	0.54 (78.3)		
Tank capacity	Coolant tank capacity		L (gal)	260 (68.7)	310 (81.9)	325 (85.9)
Machine Dimensions	Height		mm (inch)	2985 (117.5)	2985 (117.5)	3100 (122.0)
	Length		mm (inch)	2158 (85.0)	2413 (95.0)	2597 (102.2)
	Width		mm (inch)	2615 (103.0)	3110 (122.4)	3350 (131.9)
	Weight		kg (lb)	5000 (11023)	6500 (14330)	8500 (18739)
Control	NC system		-	DOOSAN FANUC i / SIEMENS S828D / HEIDENHAIN TNC620		

* 8000 r/min High torque version(FANUC only) ** 12000 r/min spindle power

*** Power capacity of 8000 r/min high torque and 12000 r/min spindle

**DOOSAN
FANUC i**

Basic Information

Basic Structure
Cutting
Performance

Detailed Information

Options
Applications
Diagrams
Specifications

Customer Support Service

No.	Item	Spec.	DOOSAN FANUC i
1	Controlled axis	Controlled axes	3 (X,Y,Z)
2		Additional controlled axes	5 axes in total
3		Least command increment	0.001 mm / 0.0001"
4		Least input increment	0.001 mm / 0.0001"
5		Interpolation type pitch error compensation	
6	Interpolation & Feed Function	2nd reference point return	G30
7		3rd / 4th reference return	
8		Inverse time feed	
9		Cylindrical interpolation	G07.1
10		Bell-type acceleration/deceleration before look ahead interpolation	
11		Automatic corner override	G62
12		Automatic corner deceleration	
13		Manual handle feed	Max. 3unit
14		Handle interruption	
15		Manual handle retrace	
16		Nano smoothing	AI contour control II is required.
17		AI APC	20 BLOCK
18	AICC I	40 BLOCK	
19	AICC II	200 BLOCK	
20	AICC II(Preview block number increase)	400 BLOCK(Special hardware and AI contour control II)	
21	Spindle & M code Function	M- code function	
22		Retraction for rigid tapping	
23		Rigid tapping	G84, G74
24	Tool Function	Number of tool offsets	400 ea
25		Tool nose radius compensation	G40, G41, G42
26		Tool length compensation	G43, G44, G49
27		Tool life management	
28		Tool offset	G45 - G48
29	Programming & Editing Function	Custom macro	
30		Macro executor	
31		Extended part program editing	
32		Part program storage	512KB(1280m)
33		Part program storage	2MB(5120m)
34		Inch/metric conversion	G20 / G21
35		Number of Registered programs	400 ea
36		Number of Registered programs	1000 ea
37		Optional block skip	9 BLOCK
38		Optional stop	M01
39		Program file name	32 characters
40		Sequence number	N 8-digit
41		Playback function	
42		Addition of workpiece coordinate system	G54.1 P1 - 48 (48 pairs)
43	Addition of workpiece coordinate system	G54.1 P1 - 300 (300 pairs)	
44	OTHER FUNCTIONS (Operation, setting & Display, etc)	Embedded Ethernet	
45		Graphic display	Tool path drawing
46		Loadmeter display	
47		Memory card interface	
48		USB memory interface	Only Data Read & Write
49		Operation history display	
50		DNC operation with memory card	
51		Optional angle chamfering / corner R	
52		Run hour and part number display	
53		High speed skip function	
54		Polar coordinate command	G15 / G16
55		Programmable mirror image	G50.1 / G51.1
56		Scaling	G50, G51
57		Single direction positioning	G60
58		Pattern data input	
59		Jerk control	AI contour control II is required.
60		Fast Data server with 1GB PCMCIA card	
61	Fast Ethernet		
62	3-dimensional coordinate conversion		
63	Figure copying	G72.1, G72.2	
64	Machining time stamp function		
65	EZ Guide I with 10.4" Color TFT	-Doosan infracore Conversational Programming Solution -.When the EZ Guide i is used, the Dynamic graphic display cannot application "	
66	Dynamic graphic display (with 10.4" Color TFT LCD)	-.Machining profile drawing. -.When the EZ Guide i is used, the Dynamic graphic display cannot application	

SIEMENS S828D

● Standard ○ Optional X N/A

No.	Item	Spec.	S828D	
1	Controlled axis	Controlled axes	3 axes	
2		Additional controlled axes	Max. 5 axes in total	
3		Least command increment	0.001mm (0.0001 inch)	
4		Least input increment	0.001mm (0.0001 inch)	
5		Travel to fixed stop with Force Control		
6	Interpolation & Feed Function	Reference point return	G75 FP=1	
7		2nd reference point return	G75 FP=2	
8		3rd / 4th reference return	G75 FP=3, 4	
9		Inverse time feedrate	G93	
10		Helical interpolation		
11		Polynomial interpolation		
12		Spline interpolation (A, B and C splines)		
13		Separate path feed for corners and chamfers		
14		Acceleration with Jerklimitation		
15		Compressor for 3-axis machining		
16	Temperature compensation			
17	Look ahead number of block	150 BLOCK		
18	Cartesian point-to-point (PTP) travel			
19	TRANSMIT/cylinder surface transformation			
20	Spindle Function	Tapping with compensating chuck/rigid tapping		
21		Retraction for rigid tapping		
22	Tool Function	Tool radius compensations in plane		
23		Number of tools/cutting edges in tool list	256/512	
24			600/1500	
25		Tool length compensation		
26		Operation with tool management		
27		Tool list		
28		Replacement tools for tool management		
29		Monitoring of tool life and workpiece count		
30		Manual measurement of tool offset		
31		Magazine list		
32	Programming & Editing Function	Number of levels for skip blocks 1		
33		Number of levels for skip blocks 8		
34		Program/workpiece management	On additional plug-in CF card	
35			On integral Hard disk PCU50.3	N/A
36			On USB storage medium (e.g. disk drive, USB stick)	
37			On network drive	
38		Program editor	Programming support for cycles program(Program Guide)	
39			CNC editor with editing functions: Marking, copying, deleting	
40			Programming graphics/free contour input (contour calculator)	
41			ShopMill Machining step programming	
42		Technology cycles for drilling/milling		
43		Pocket milling free contour and islands stock removal cycle		
44		Residual material detection		
45		Access protection for cycles		
46		Programming support can be extended, e.g. customer cycles		
47	2D simulation			
48	3D simulation, finished part			
49	OTHERS FUNCTIONS (Operation, setting & Display, etc)	Switchover: inch/metric		
50		Manual measurement of zero/work offset		
51		Automatic tool/workpiece measurement		
52		Reference point approach, automatic/via CNC program		
53		Execution from USB or CF card interface on operator panel front		
54		Execution from network drive		
55		10.4" color display		
56		15.0" color display		
57		Alarms and messages		
58		Remote Control System (RCS) remote diagnostics	RCS Host remote diagnostics function	
59	RCS Commander (viewer function)			
60	Automatic measuring cycles			

Basic Information

Basic Structure
Cutting
Performance

Detailed Information

Options
Applications
Diagrams
Specifications

Customer Support Service

HEIDENHAIN TNC620

NO.	Item	Spec.	TNC 620
1	Axes	Controlled axes	3 axes
2		Additional Controlled axes	Max. 18 axes in total
3		Least command increment	0.0001 mm (0.0001 inch), 0.0001°
4		Least input increment	0.0001 mm (0.0001 inch), 0.0001°
5		MDI / DISPLAY unit	15.1 inch TFT color flat panel
6		Program memory for NC programs	SSDR
7	Commissioning and diagnostics	Data interfaces	Ethernet interface
8			USB interface (USB 2.0)
9	Machine functions	Look-ahead (Intelligent path control by calculating the path speed ahead of time)	Max. 1024 blocks.
10			Max. 5000 blocks.
11		HSC filters	
12		Switching the traverse ranges	
13	User functions	Tool compensation	In the working plane and tool length
14			Radius-compensated contour lookahead for up to 99 blocks (M120)
15			Three-dimensional tool radius compensation
16		Tool table	Central storage of tool data
17			Multiple tool tables with any number of tools
18		MDI mode	
19		Tilting the working plane with Cycle 19	
20		Tilting the working plane with the PLANE function	
21		Manual traverse in tool-axis direction	after interruption of program run
22		Function TCPM	Retaining the position of tool tip when positioning tilting axes
23	Rotary table machining	Programming of cylindrical contours as if in two axes	
24		Feed rate in distance per minute	
25	New 3-D simulation graphics in full detail		
26	Program verification graphics	Plan view, view in three planes, 3-D view	
27		3-D line graphics	
28	Enhanced file management		
29	Context-sensitive help for error messages		
30	TNCguide	Browser-based, context-sensitive helpsystem	
31	Calculator		
32	"Save As" function		
33	Fixed cycles	Pecking	Cycle 1
34		Tapping	Cycle 2
35		Slot milling	Cycle 3
36		Pocket milling	Cycle 4
37		Circular pocket	Cycle 5
38		Datum shift	Cycle 7
39		Mirror imaging	Cycle 8

NO.	Item	Spec.	TNC 620
40	Fixed cycles	Dwell time	Cycle 9 ●
41		Rotation	Cycle 10 ●
42		Scaling factor	Cycle 11 ●
43		Program call	Cycle 12 ●
44		Oriented spindle stop	Cycle 13 ●
45		Rigid tapping (controlled spindle)	Cycle 17 ●
46		Working plane	Cycle 19 ○
47		Cylinder surface	Cycle 27 ○
48		Cylinder surface slot milling	Cycle 28 ○
49		Cylinder surface ridge milling	Cycle 29 ○
50		Tolerance (HSC mode, TA)	Cycle 32 ○
51		Rigid tapping, new	Cycle 207 ●
52		Tapping with chip breaking	Cycle 209 ●
53		Polar pattern	Cycle 220 ●
54		Cartesian pattern	Cycle 221 ●
55		Engraving	Cycle 225 ●
56		Multipass milling	Cycle 230 ●
57		Face milling	Cycle 233 Enhanced with side walls, milling direction and strategy ●
58		Centering	Cycle 240 ●
59		Single-lip deep-hole drilling	Cycle 241 ●
60		Datum setting	Cycle 247 ●
61		Rectangular pocket, complete	Cycle 251 ●
62		Circular pocket, complete	Cycle 252 ●
63		Slot, complete	Cycle 253 ●
64		Circular slot, complete	Cycle 254 ●
65		Rectangular stud, complete	Cycle 256 ●
66		Circular stud, complete	Cycle 257 ●
67		Thread milling	Cycle 262 ●
68	Thread milling/countersinking	Cycle 263 ●	
69	Thread drilling/milling	Cycle 264 ●	
70	Helical thread drilling/milling	Cycle 265 ●	
71	Outside thread milling	Cycle 267 ●	
72	Trochoidal milling	Cycle 275 ●	
73	Touch probe cycles	Calibrating the effective radius on a circular stud	●
74		Calibrating the effective radius on a sphere	●
75	Cycles for automatic workpiece inspection	Save kinematics	○
76		Measure kinematics	○
77		Preset compensation	○
78		TS calibration of length	○
79		TS calibration in a ring	○
80		TS calibration on stud	○
81	Options	Software option 1	Rotary table machining, Coordinate transformation, Interpolation ○
82		Software option 2	3-D machining, Interpolation ○

Responding to Customers Anytime, Anywhere

Basic Information

- Basic Structure
- Cutting
- Performance

Detailed Information

- Options
- Applications
- Diagrams
- Specifications

Customer Support Service

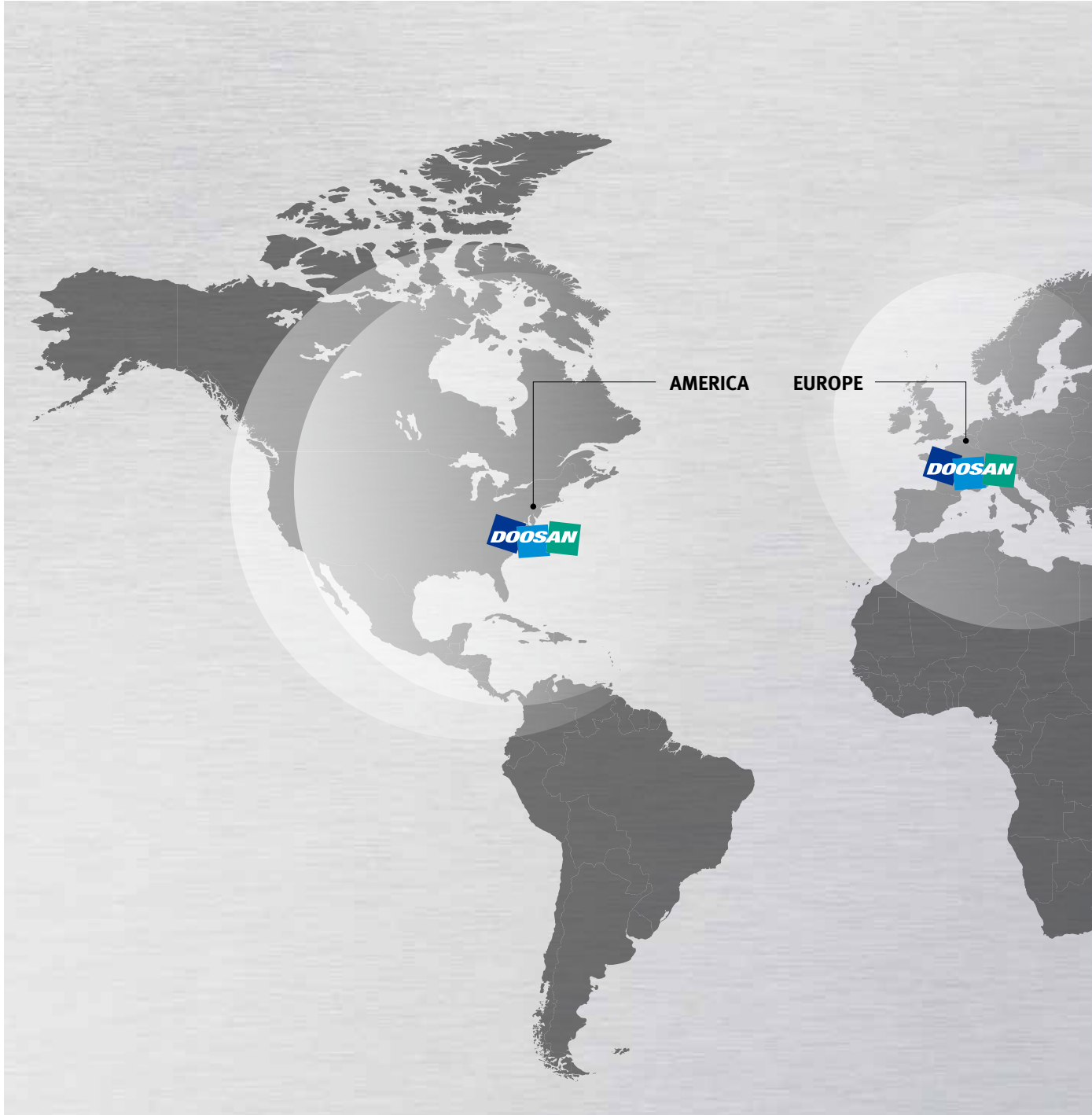

Global Service Support Network

Corporations

5

Dealer Networks

122

Technical Centers

18

Factories

3

Technical Center: Sales Support, Service Support, Parts Support

Doosan Machine Tools' Global Network, Responding to Customer's Needs nearby, Anytime, Anywhere

Doosan machine tools provides a system-based professional support service before and after the machine tool sale by responding quickly and efficiently to customers' demands. By supplying spare parts, product training, field service and technical support, we can provide top class support to our customers around the world.



Domestic Service Support Network

Integrated Support Centers	2	Sales Branch Offices	7	Post-Sales Service Centers	6	Designated Repair Service Centers	31
----------------------------	---	----------------------	---	----------------------------	---	-----------------------------------	----

Customer Support Service

We help customers to achieve success by providing a variety of professional services from pre-sales consultancy to post-sales support.

Supplying Parts



- Supplying a wide range of original Doosan spare parts
- Parts repair service

Field Services



- On site service
- Machine installation and testing
- Scheduled preventive maintenance
- Machine repair

Technical Support



- Supports machining methods and technology
- Responds to technical queries
- Provides technical consultancy

Training



- Programming / machine setup and operation
- Electrical and mechanical maintenance
- Applications engineering

Major Specifications

DNM series



Description	UNIT	DNM 4500	DNM 5700	DNM 6700
Max. spindle speed	r/min	8000 {12000}*}		
Max. spindle power	kW (Hp)	18.5(24.8) {15(20.1)**}		
Max. spindle torque	N·m (lb·ft)	118 {86.9} {286(210.9)**}		
Taper	-	ISO #40		
Travel distance (X / Y / Z)	mm (inch)	800 / 450 / 510 (31.5 / 17.7 / 20.1)	1050 / 570 / 510 (41.3 / 22.4 / 20.1)	1300 / 670 / 625 (51.2 / 26.4 / 24.6)
Tool storage capa.	ea	30 {40}		
Table size	mm (inch)	1000 x 450 (39.4 x 17.7)	1300 x 570 (51.2 x 22.4)	1500 x 670 (59.1 x 26.4)
NC system	-	DOOSAN FANUC i / SIEMENS S828D / HEIDENHAIN TNC620		

{ } Optional ** 8000 r/min High torque version



Doosan Machine Tools

<http://www.doosanmachinetools.com>

www.facebook.com/doosanmachinetools

Optimal Solutions for the Future

Head Office

Yeonkang Bldg., 6th FL., 270, Yeonji-dong,
Jongno-gu, Seoul, Korea
Tel +82-2-3670-5345 / 5362
Fax +82-2-3670-5382

Doosan Machine Tools China

Room 101,201,301, Building 39 Xinzhuang Highway
No.258 Songjiang District,China Shanghai(201612)
Tel +86 21-5445-1155
Fax +86 21-6405-1472

Doosan Machine Tools Japan

#2412, Mita Kokusai Bldg. 1-4-28 Mita,
Minato-ku, Tokyo 108-0073, Japan
Tel +81 3 5730 9013
Fax +81 3 5730 9016

Doosan Machine Tools America

19A Chapin Rd., Pine Brook, NJ 07058, U.S.A.
Tel +1-973-618-2500
Fax +1-973-618-2501

Doosan Machine Tools Europe

Emdener Strasse 24, D-41540 Dormagen, Germany
Tel +49-2133-5067-100
Fax +49-2133-5067-111

Doosan Machine Tools India

106 / 10-11-12, Amruthahalli, Byatarayanapura,
Bellary road, Bangalore-560 092, India
Tel +91-80-4266-0122 / 121 / 100



* For more details, please contact Doosan Machine Tools.

* The specifications and information above-mentioned may be changed without prior notice.

* Doosan Machine Tools Co., Ltd. is a subsidiary of MBK Partners. The trademark  DOOSAN is used under a licensing agreement with Doosan Corporation, the registered trademark holder.