



# Lynx 220 series

High Productivity Turning Center



# Lynx 220 series



# High Productivity Turning Center

The Lynx 220 series is a accurate, high productivity turning center designed with ultra fast rapids and high-speed turret indexing providing greater value and cost performance.



# High Speed

## Structure



FEM analysis used to design a stable body. (FEM : Finite Element Method)

### Max. turning dia. X length

- Lynx 220A [LA] **ø 320 x 322 [ 542 ] mm**  
(ø 12.6 x 12.7 [ 21.3 ] inch)
- Lynx 220B [LB] / 220C [LC] **ø 320 x 305 [ 525 ] mm**  
(ø 12.6 x 12.0 [ 20.7 ] inch)
- Lynx 220M [LM] **ø 250 x 290 [ 510 ] mm**  
(ø 9.8 x 11.4 [ 20.1 ] inch)
- Lynx 220LMSA / LMSC **ø 300 x 510 mm**  
(ø 11.8 x 20.1 inch)



The heavily ribbed torque tube design prevents twisting and deformation. All guideways are wide wrap-around rectangular type for unsurpassed long-term rigidity and accuracy.

## Rapid Traverse



Roller-type LM Guide is mounted on the machine to improve rigidity and feedrates. Each axis is powered by a maintenance free digital AC servo motor. These high torque drive motors are connected to the ball screws without intermediate gears for quiet and responsive slide movement with virtually no backlash.

	X-axis	Z-axis	B-axis
Lynx 220 / M	<b>30 m/min</b> (1181 ipm)	<b>36 m/min</b> (1417 ipm)	-
Lynx 220LMS			<b>30 m/min</b> (1181 ipm)

## Main Spindle

The C-axis is positioned in degree increments of 0.001. Through spindle synchronization with the X and Z axes, three dimensional contouring, complex and prismatic machining can be accomplished.



### Max. spindle speed

Lynx 220A / B / C  
**6000 / 5000 / 4000 r/min**

Lynx 220MA / C  
**6000 / 4500 r/min**

Lynx 220LMSA / C  
**6000 / 4500 r/min**

### Max. bar working dia.

Lynx 220A / B / C  
**∅ 45 / 51 / 65 mm**  
 (∅ 1.8 / 2.0 / 2.6 inch)

Lynx 220MA / C  
**∅ 51 / 65 mm**  
 (∅ 2.0 / 2.6 inch) [ Main / Sub ]

Lynx 220LMSA / C  
**∅ 51 / 65 mm**  
 (∅ 2.0 / 2.6 inch) [ Main / Sub ]

## Headstock and spindle



The headstock and main spindle are manufactured in a temperature controlled environment then assembled and tested in our clean room. The heavy duty cartridge type spindle is supported by a triple row angular ball bearing in the front, with a row cylindrical roller bearing in the rear. This combination of bearings is very effective in refraining from thermal displacement of its front nose and improving high speed performance and its rotational precision.

## Main Spindle Power-torque Diagram

### Lynx 220A / LA

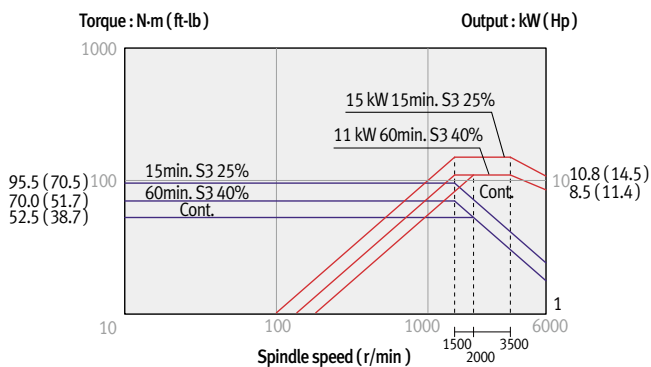

**6000 r/min, 15 / 11 kW (20.1 / 14.8 Hp)**

### Lynx 220B / LB

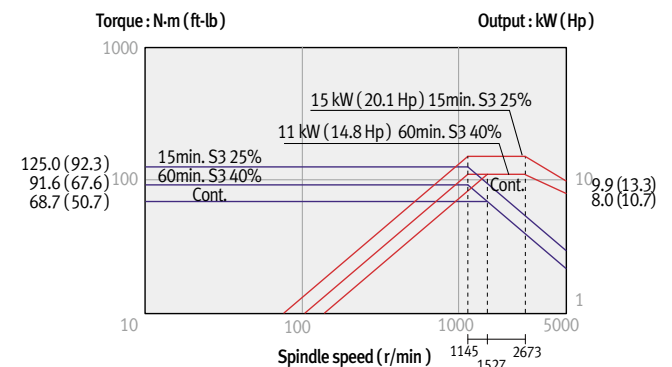

**5000 r/min, 15 / 11 kW (20.1 / 14.8 Hp)**

# Main Spindle Power-torque Diagram

## Lynx 220C / LC

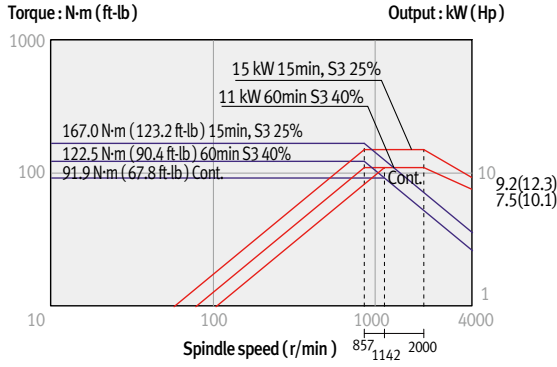

**4000 r/min, 15 / 11 kW (20.1 / 14.8 Hp)**

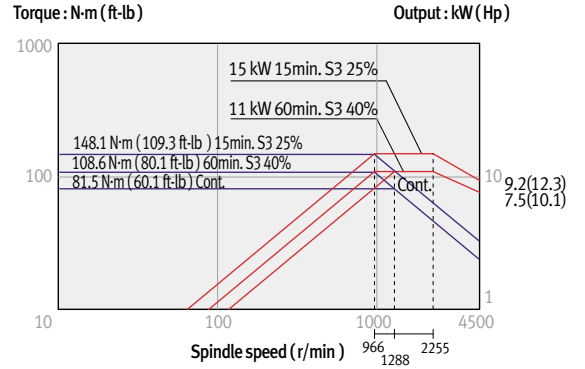

**4500 r/min, 15 / 11 kW (20.1 / 14.8 Hp) opt.**

## Lynx 220MA / LMA

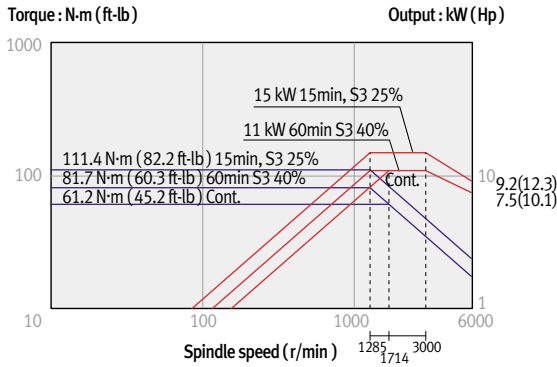

**6000 r/min, 15 / 11 kW (20.1 / 14.8 Hp)**

## Lynx 220LMSA

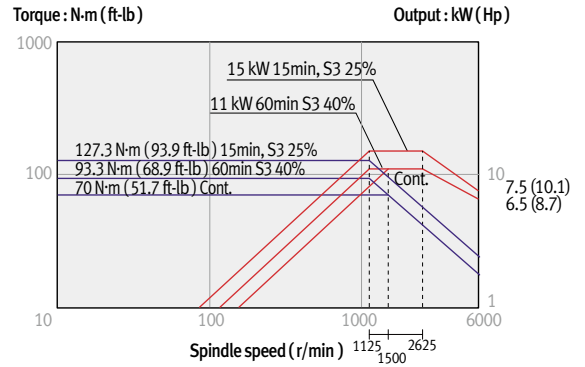

**6000 r/min, 15 / 11 kW (20.1 / 14.8 Hp)**

## Lynx 220MC / LMC / LMSC

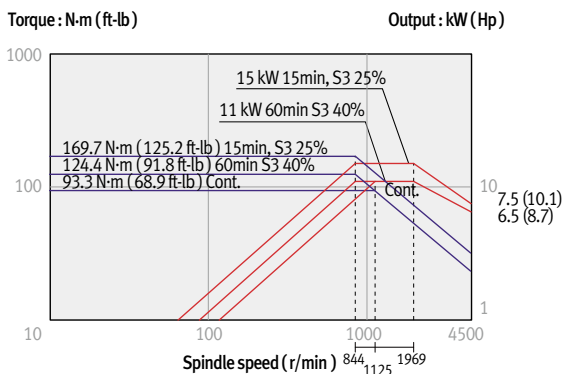

**4500 r/min, 15 / 11 kW (20.1 / 14.8 Hp)**



# High Productivity

## 2 axis Servo Turret (A/B/C)

Rigidity and efficiency provide increased machine performance.



heavy duty turret features a large 210mm diameter curvic coupling and 39 kN of hydraulic clamp force. The heavy duty design provides unsurpassed rigidity for heavy stock removal, fine surface finishes, long boring bar overhang ratios, and extended tool life.

All turret rotations are controlled by high torque servo motor and turret indexing is non-stop-bi-directional, with a 0.11 second station to station index time.

Index time (1-station index)

**0.11 s**

No. of tool stations

**12<sup>ea</sup>**

## BMT Turret (MA / MC / LMA / LMC / LMSA / LMSC)

BMT turret makes it possible to complete complicated parts requiring many tools in just one set-up. Reliable servo driven turret reduces the total cycle time required to machine parts.



Index time (1-station index)

**0.11s**

No. of tool stations

Lynx 220MA / MC / LMA / LMC / LMSA / LMSC

**12<sup>ea</sup> (24 position index)**

## Rotary tool spindle power-torque diagram

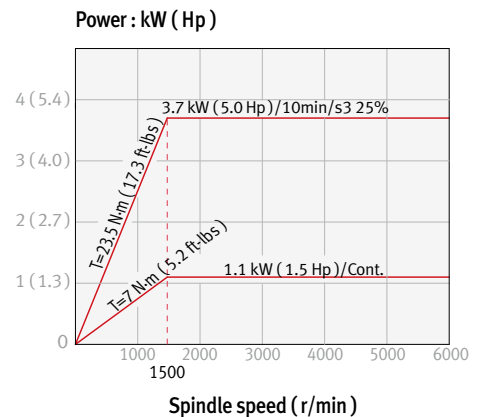

Lynx 220M / LM / LMS (BMT45P)

## Tailstock

Widely spaced guideways and heavy-duty design of the tailstock body ensure ample rigidity. The tailstock body is positioned by traction bar, which engages with the carriage. The traction bar movement and hydraulic body clamping are manual.

Tailstock specification		Lynx 220ser
Tailstock travel	mm (inch)	550 (21.7), { 330 (13.0) }
Tailstock quill diameter	mm (inch)	65 (2.6)
Taper hole of tailstock quill		MT4 <Live center>
Tailstock quill travel	mm (inch)	80 (3.1)

{ } : option

Note) Tail Stock

**std.** Lynx 220LA / LB / LC / LMA / LMC

**opt.** Lynx 220A / B / C

**N.A.** Lynx 220MA / MC / LMS

**std.** Standard

**opt.** Optional

**N.A.** Not Available



## Sub Spindle (LMSA / LMSC)

The travel time of the workpiece is minimized, because the travel of workpiece between both spindles is carried out under a state of revolution through the synchronized control of revolution speed. In addition, the cutting performance is enhanced because the cross-sectional adhesion of the workpiece at the axis of the servo spindle is secured by the use of a torque skip function when travelling to the B axis.



Max. spindle speed

**6000 r/min**

C1, C2-axis index

**360°**  
(in 0.001 increment)

## Sub-spindle power-torque diagram

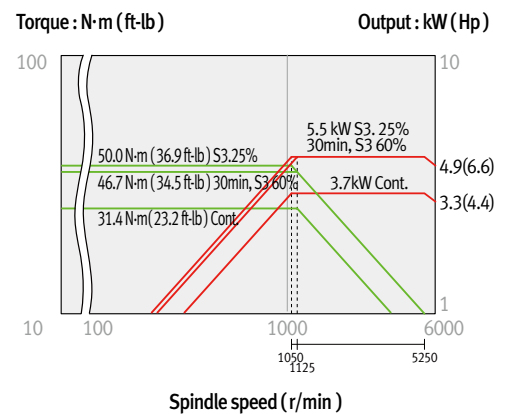

**6000 r/min, 5.5 / 3.7 kW (7.4 / 5.0 Hp)**



# Operation Convenience

## Doosan's New Operation Panel

New Doosan operation panel designed ergonomically and 10.4" color\* LCD provide convenient operation for operators



1. 10.4" color\* LCD : Easy to control and programming
2. Unique operator panel of Doosan Infracore designed with membrane switches
3. New operator panel for all the models with enhanced accessibility
4. User configurable, detachable buttons to set up customized options

- 1 Doosan-Fanuc i series**
- 2 10.4" color\* TFT LCD monitor**  
Large 10.4" LCD screen showing error messages of the machine and controller improves operator's work convenience.
- 3 PCMCIA Card**
- 4 USB Port**
- 5 Ethernet Connectivity ( embedded )**
- 6 Swing-type Panel**  
The operation panel can swing up to 88° to provide the operator with convenience during work.

\* 10.4" color LCD : it can be an optional feature for parts of models

## Optional Equipment

Chuck air ( or coolant ) blower



Collet chuck



Chip conveyor



Tool pre-setter



Signal tower



Work measurement



Oil skimmer



Part catcher



Part conveyor



# High Performance & Accuracy

More powerful revolving motor is adapted to improve the productivity.

## Accuracy

Doosan offers its customers unsurpassed levels of accuracy by applying the latest design techniques and rigorous testing processes.

### Roughness

**0.07  $\mu\text{m}$   
(Ra)**

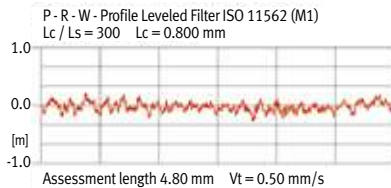

Material		Brass
Cutting Feed	mm/rev (ipr)	0.025 mm/rev
Cutting Depth	mm (inch)	0.025 mm
Cutting Speed	m/min (ipm)	300 m/min (11811.0 ipm)
Tool		Diamond (Nose R0.1)

※ This is actual cutting result. It might be not available under certain circumstances

### Roundness

**0.3  $\mu\text{m}$**

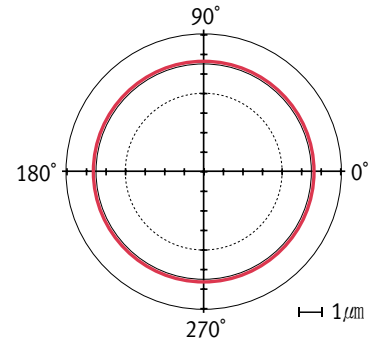

## Machine Capacity

### Heavy duty cutting

Making full use of the high output motor, heavy-duty O.D. cutting is powerful and precise even with large workpieces.

### Center drilling

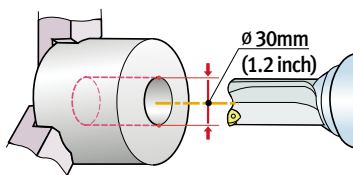

Chip removal rate

**320  $\text{cm}^3/\text{min}$  (19.5  $\text{m}^3/\text{inch}$ )**

Cutting depth

**4 mm (0.16 inch)**

**Carbon steel, SM45C**

Cutting speed

**200 m/min (7874.0 ipm)**

Feedrate

**0.4 mm/rev (0.0 ipr)**

Chip removal rate

**168  $\text{cm}^3/\text{min}$  (10.25  $\text{m}^3/\text{inch}$ )**

**Carbon steel, SM45C**

Cutting speed

**80 m/min (3149 ipm)**

Feedrate

**0.28 mm/rev (0.011 ipr)**

## Productivity

Machining times can be reduced.

- Productivity gains can be achieved through Lynx series.



Material : Carbon steel, SM45C  
Size : ø 62 x 66mm  
(ø2.4 x 2.6 inch)

Process	Cutting time s	Cutting speed m/min (ipm)	Feed rate m/rev
U-drilling (ø30 mm)	18.1	120 (4724.4)	0.2
O.D. cutting (Rough)	9.2	200 (7874.0)	0.45
O.D. cutting (Finish)	18.2	250 (9842.5)	0.2
O.D. grooving1 (4 mm)	3.5	140 (5511.8)	0.2
O.D. grooving2 (8 mm)	5.8	140 (5511.8)	0.17
O.D. threading (M45 x P1.5)	10.4	201 (7913.4)	1.5
Cut-off cutting (4 mm)	15.1	120 (4724.4)	0.1

※ Cutting time table shown above is the results from real test cutting. The results can be different on cutting condition and strategy.

**Total cutting time 80.3s**  
in heavy cutting conditions

# Tooling system

## Lynx 220A / B / C [LA / LB / LC] series

Unit : mm (inch)

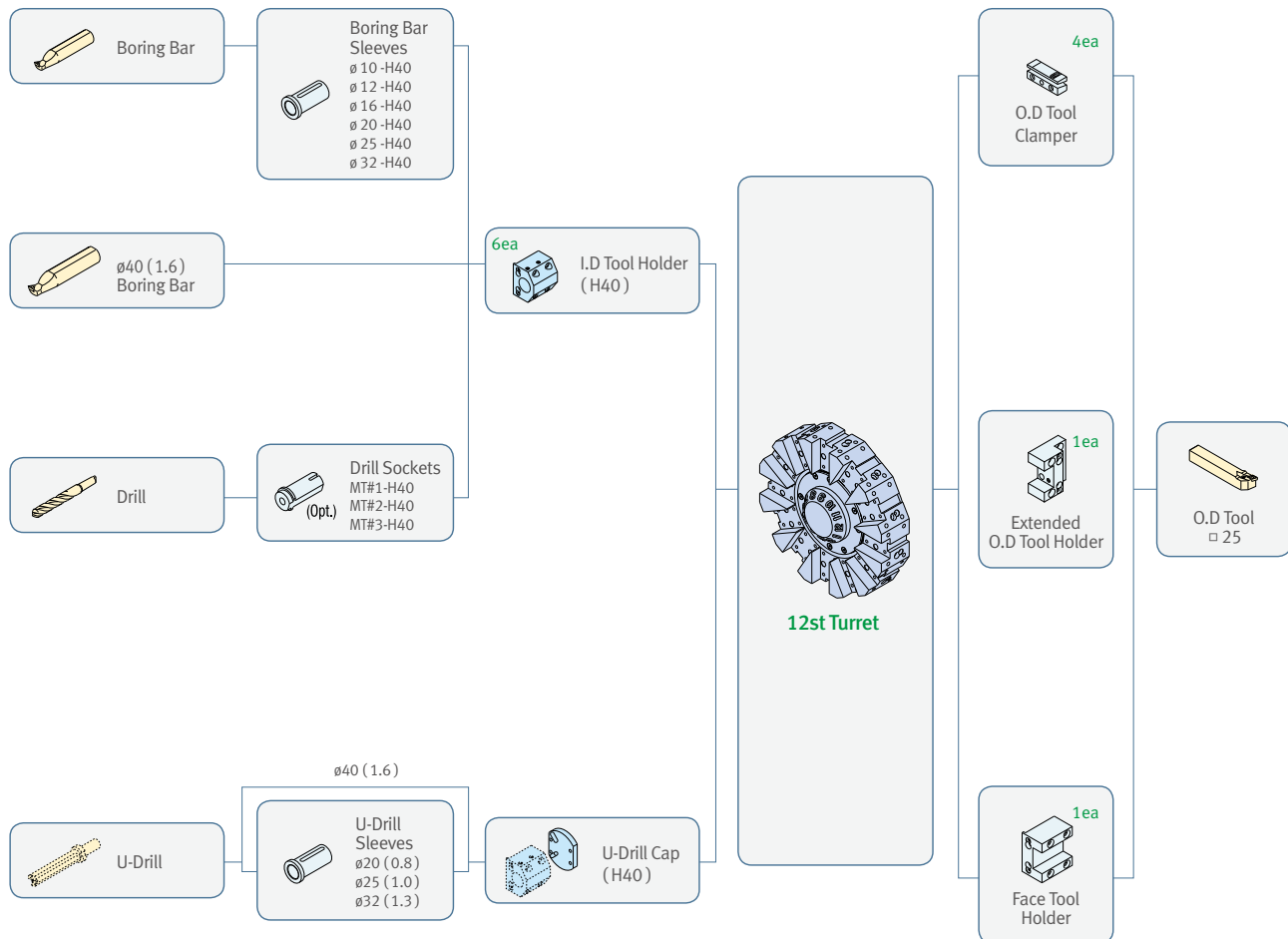

Note) Above tooling system is our recommendation.  
Depending on export condition, the standard tooling packed with the machine can be different.

# Tooling System

## Lynx 220MA / MC [LMA / LMC]

Unit : mm ( inch )

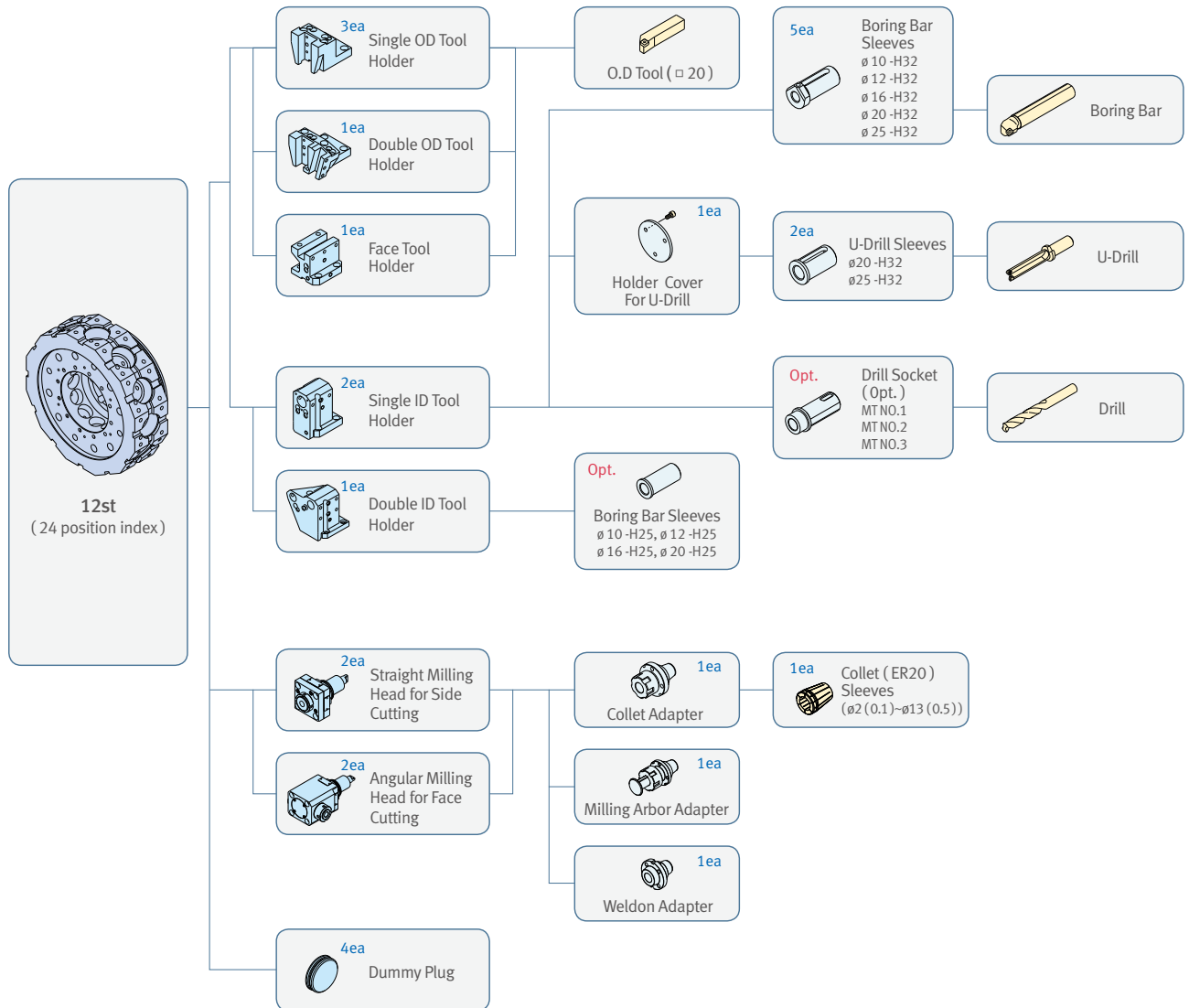

Note) Above tooling system is our recommendation.  
Depending on export condition, the standard tooling packed with the machine can be different.

# Lynx 220LMSA / LMSC

Unit : mm ( inch )

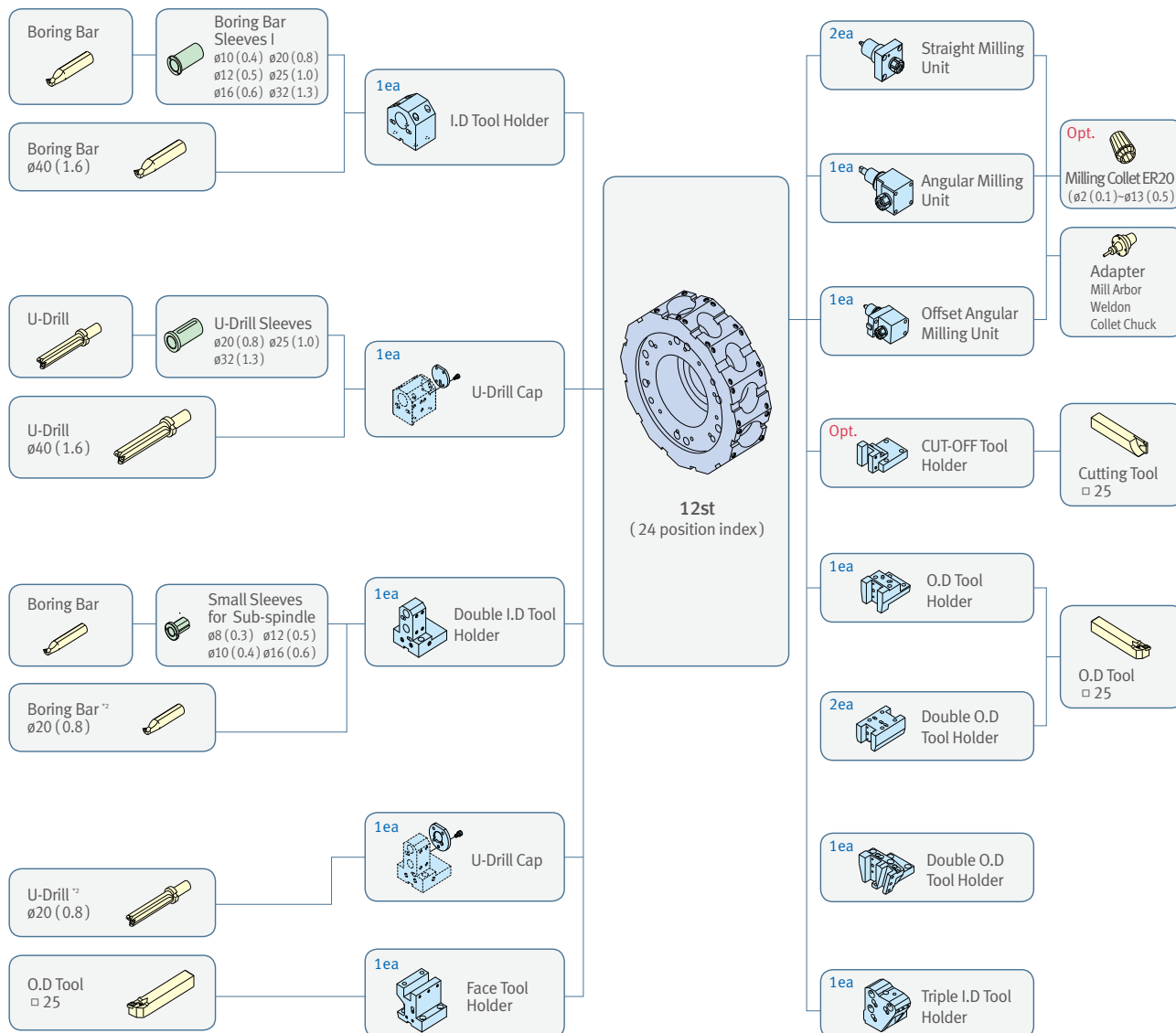

Note ) Above tooling system is our recommendation.  
Depending on export condition, the standard tooling packed with the machine can be different.

# Working Range

## Lynx 220A / B / C series

Unit : mm (inch)

OD Tool Holder

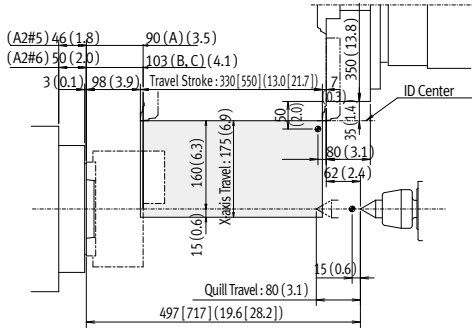

ID Tool Holder

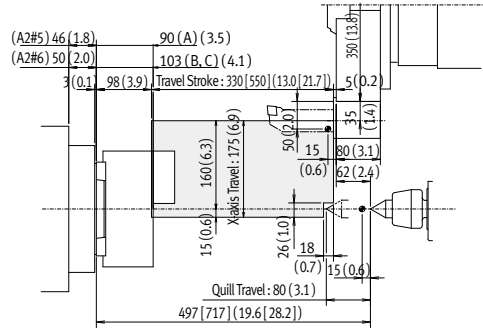

Extended OD Tool Holder

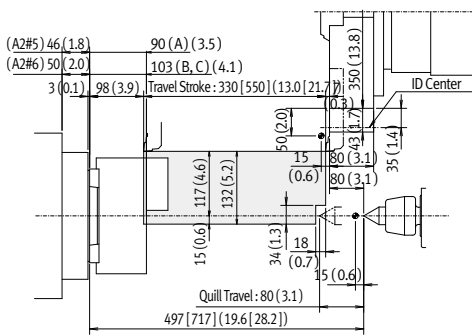

Face Tool Holder

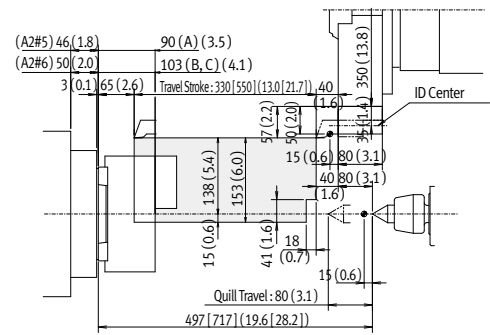

## Lynx 220LMSA [LMSC]

Unit : mm (inch)

Single OD Tool Holder

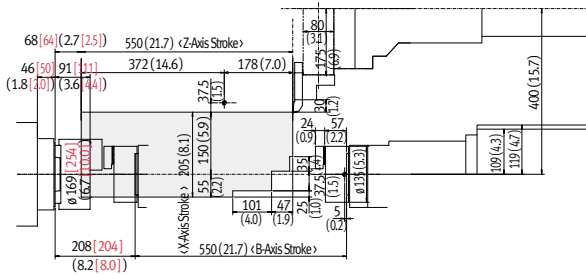

Single ID Tool Holder

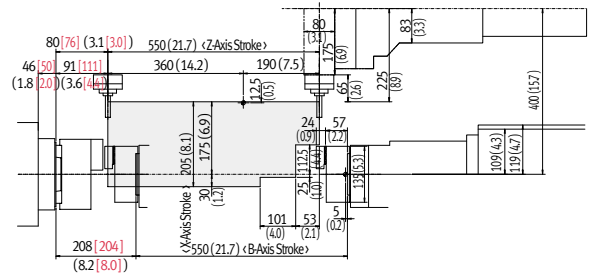

Double OD Holder

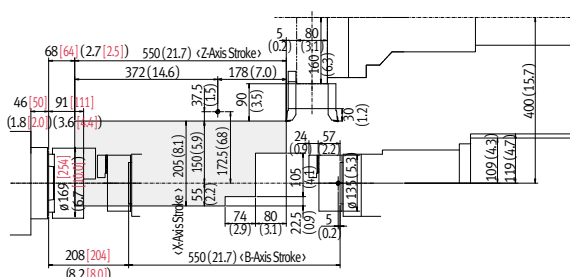

Double ID Tool Holder

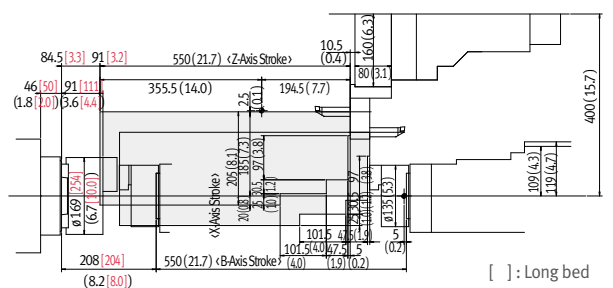

[ ] : Long bed



# Lynx 220M [LM]

Unit : mm (inch)

## Single OD Tool Holder

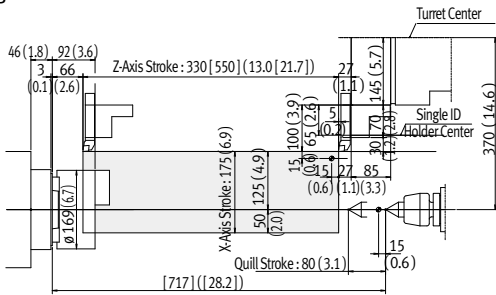

## Single ID Tool Holder

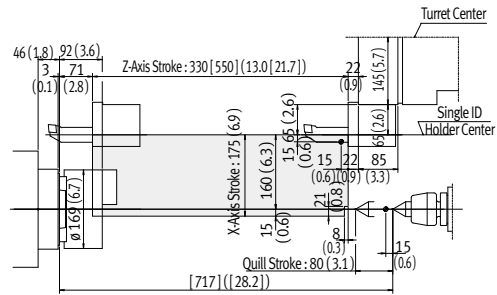

## Double OD Holder

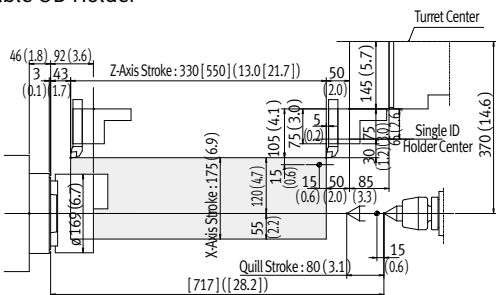

## Double ID Tool Holder

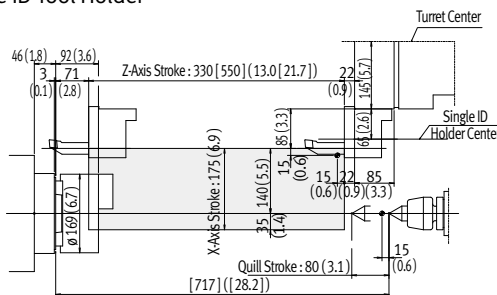

## Straight Rev. Tool Holder

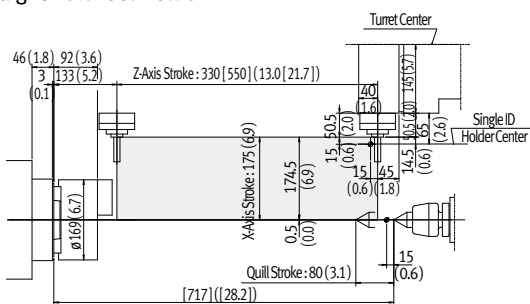

## Angular Rev. Tool Head

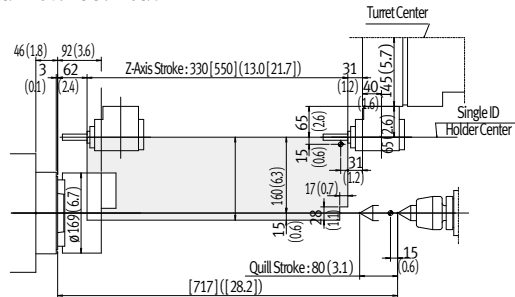

## Face Tool Holder

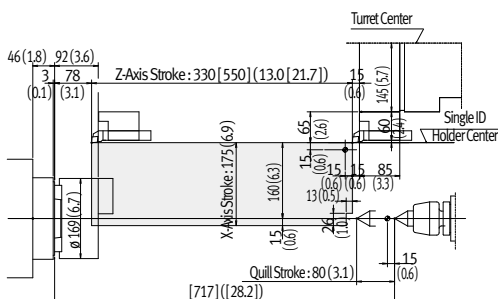

# Tool Interference Diagram

## Lynx 220A / B / C / LA / LB / LC

Unit : mm (inch)

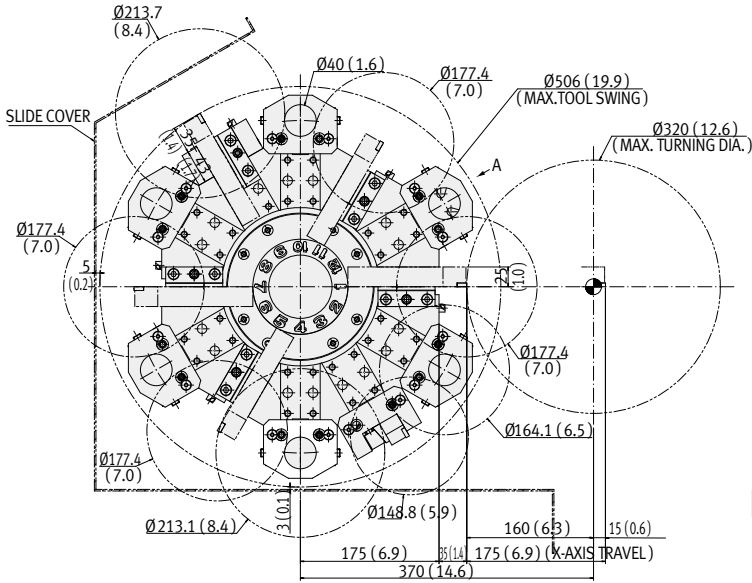

## Lynx 220MA / MC / LMA / LMC

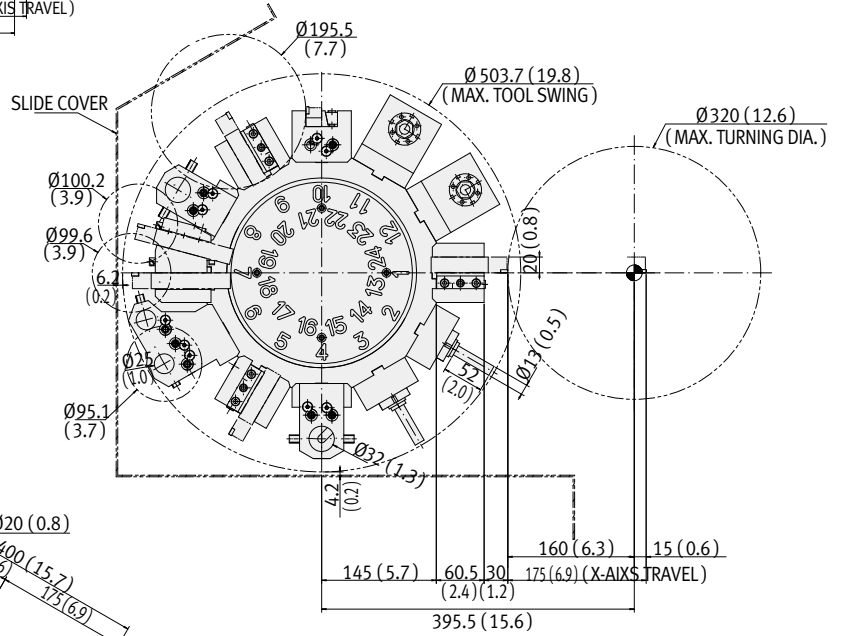

## Lynx 220LMSA / LMSC

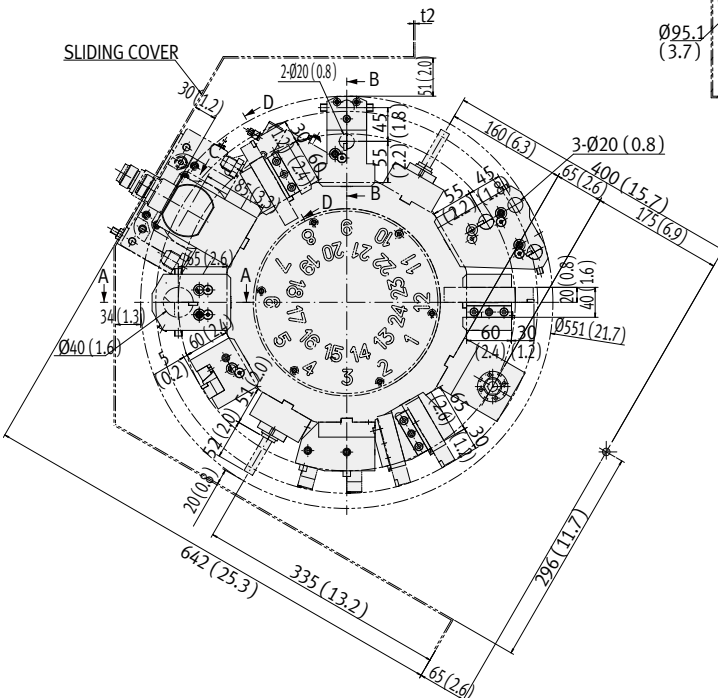

# External Dimensions

## Lynx 220A / B / C [LA / LB / LC]

Unit : mm (inch)

Front View

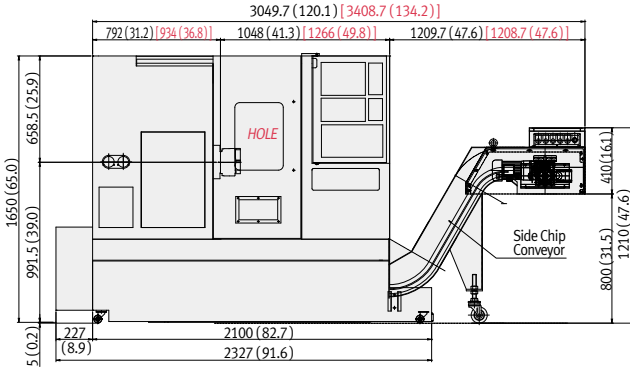

Unit : mm (inch)

Side View

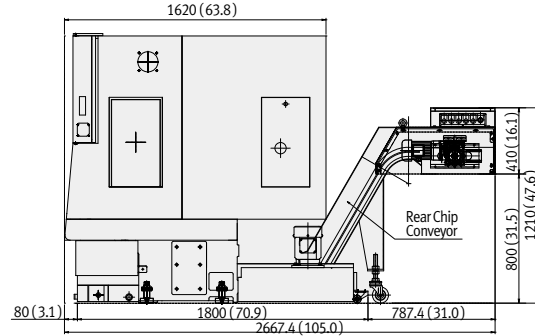

## Lynx 220MA / MC [LMA / LMC]

Front View

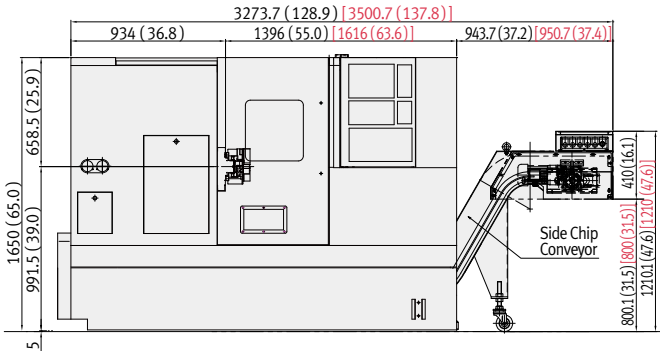

Side View

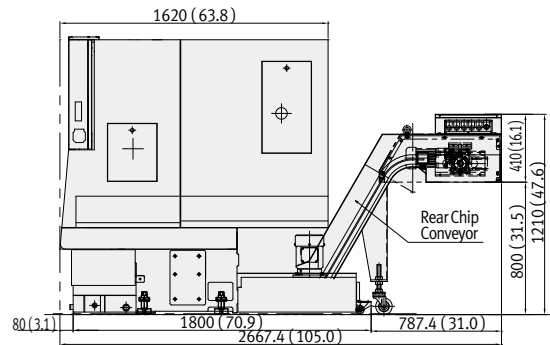

## Lynx 220LMSA / LMSC

Front View

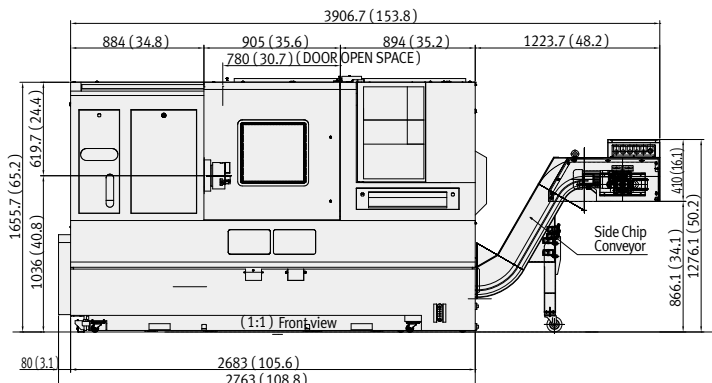

Side View

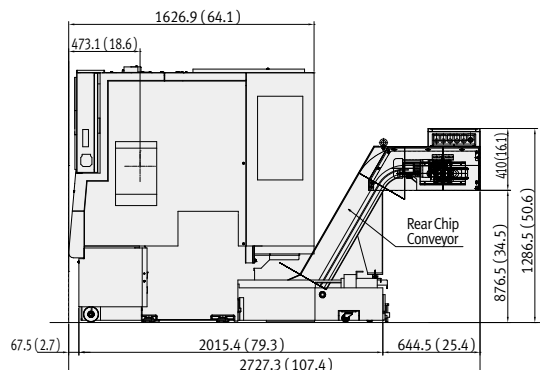

# Machine Specifications

Features		Unit	Lynx 220A [LA]	Lynx 220B [LB]	Lynx 220C [LC]	Lynx 220MA [LMA]	Lynx 220MC [LMC]	Lynx 220LMSA	Lynx 220LMSC	
Capacity	Swing over bed	mm (inch)	510 (20.1)					600 (23.6)		
	Swing over saddle	mm (inch)	290 (11.4)					400 (15.7)		
	Recom. Turning diameter	mm (inch)	170 (6.7)	210 (8.3)		170 (6.7)	210 (8.3)		170 (6.7)	210 (8.3)
	Max. Turning diameter	mm (inch)	320 (12.6)			250 (9.8)			300 (11.8)	
	Max. Turning length	mm (inch)	322 [542] (12.7 [21.3])	305 [525] (12.0 [20.7])		290 [510] (11.4 [20.1])			510 (20.1)	
	Chuck size	inch	6	8	8	6	8	6	8	
	Bar working diameter	mm (inch)	45 (1.8)	51 (2.0)	65 (2.6)	51 (2.0)	65 (2.6)	51 (2.0)	65 (2.6)	
Travels	Travel distance	X-axis	175 (6.9)					205 (8.1)		
		Z-axis	330 [550] (13.0 [21.7])					330 [550] (13.0 [21.7])		
	B-axis	-					550 (21.7)			
Feedrate	Rapid Traverse Rate	X-axis	30 (1181.1)					-		
		Z-axis	36 (1417)					-		
	B-axis	-					30 (1181.1)			
	Cutting feedrate	m/min (ipm)	500 / 500 (19.7 / 19.7)							
Main spindle	Max. Spindle speed	r/min	6000	5000	4000	6000	4500	6000	4500	
	Spindle nose	ASA	A2 #5	A2 #6	A2 #6	A2 #5	A2 #6	A2 #5	A2 #6	
	Spindle bearing diameter (Front)	mm (inch)	90 (3.5)	100 (3.9)	110 (4.3)	90 (3.5)	110 (4.3)	90 (3.5)	110 (4.3)	
	Spindle through hole	mm (inch)	53 (2.1)	61 (2.4)	76 (3.0)	61 (2.4)	76 (3.0)	61 (2.4)	76 (3.0)	
Min. spindle indexing angle (C-axis)	deg	-					0.001			
No. of tool stations	ea	12					12 (24 POSITION INDEX)			
Turret	OD tool size	mm (inch)	25 x 25 (1.0 x 1.0)			20 x 20 (0.8 x 0.8)				
	Max. boring bar size	mm (inch)	40 (1.6)			32 (1.3) (SINGLE ID) / 25 (1.0) (DOUBLE ID)		40 (1.6) (MAIN) / 20 (0.8) (SUB)		
	Turret Indexing time (1 station swivel)	s	0.11							
	Max. Rotary tool speed	r/min	-			6,000				
Tail Stock	Quill diameter	mm (inch)	65 (2.6)					-		
	Quill bore taper	MT	MT#4					-		
	Quill travel	mm (inch)	80 (3.1)					-		
Sub spindle	Spindle speed	r/min	-					6,000		
	Spindle nose	FLAT	-					ø110		
	Spindle bearing diameter (Front)	mm (inch)	-					75 (3.0)		
	Spindle through hole	mm (inch)	-					43 (1.7)		
	Min. spindle indexing angle (C-axis)	deg	-					0.001		
Motors	Main spindle motor power (30min./cont.)	kW (Hp)	15 / 11 (20.1 / 14.8)						-	
	Sub spindle motor power	kW (Hp)	-					5.5 / 3.7 (7.4 / 5.0)		
	Rotary tool motor power	kW (Hp)	-			3.7 (5.0)		3.7 (5.0)		
	Coolant pump motor power	kW (Hp)	0.4 (0.5)					0.9 (1.2)		
Power source	Electric power supply (rated capacity)	kVA	23.7					31.71		
Machine Dimensions	Height	mm (inch)	1655 (65.2)						-	
	Length	mm (inch)	2325 [2560] (91.5 [100.8])			2410 [2630] (94.9 [103.5])			2763 (108.8)	
	Width	mm (inch)	1600 (63.0)					1627 (64.1)		
	Weight	kg (lb)	2900 [3100] (6393.3 [6834.2])			3100 [3300] (6834.2 [7275.1])		3400 (7495.6)		3500 (7716.1)

## Standard feature

- Coolant supply equipment
- Foot switch
- Front door interlock
- Full enclosure chip and coolant shield
- Hand tool kit (including small tool for operations)
- Hydraulic chuck and actuating cylinder (tool holders & boring sleeves)
- Hydraulic power unit
- Levelling jack screw and plates
- Lubrication equipment
- Soft jaws
- Standard tooling kit
- Tail stock (Lynx 220LA / LB / LC / LMA / LMC)
- Work light

## Optional feature

- Additional tool holders & sleeves
- Air blast for chuck jaw cleaning
- Air gun
- Automatic door
- Automatic measuring system (in process touch probe)
- Automatic power off
- Automatic work loading
- Bar feeder interface
- Chip conveyor
- Chip bucket
- Hardened & ground jaws
- Oil skimmer
- Parts catcher (Lynx 220 : ø 65 x L140)
- Pressure switch for chucking pressure check
- Proximity switches for chuck clamp detection
- Proximity switches for tail stock quill position detection\*1
- Signal tower (yellow, red, green)
- Special chucks
- Tool pre-setter (hydraulic type)
- Tool pre-setter (manual type)

\*1 : This is available as option when tail stock is applied to the machine.

- The specifications and information above-mentioned may be changed without prior notice.
- For more details, please contact Doosan

# NC Unit Specifications

## DOOSAN-FANUC i Series

### AXES CONTROL

- Controlled axes	X, Z (Lynx 220)
	X, Z, C (Lynx 220M / LM)
	X, Z, C, A, B (Lynx 220LMSA / LMSC)
- Cs contouring control*	
- Simultaneous controlled axes	4 axes (Lynx 220 / M / LM / LMSA / LMSC)
- Axis control by PMC	
- Backlash compensation for each rapid traverse and cutting feed	
- Chamfering on / off	
- Emergency stop	
- Follow-up	
- HRV2 control	
- Inch / Metric conversion	
- Increment system 1/10	0.0001 / 0.00001 mm/inch
- Interlock	All axes / each axis
- Least input command	0.001 / 0.0001 mm/inch
- Machine lock	All axes / each axis
- Mirror image	
- Overtravel	
- Position switch	
- Servo off	
- Stored stroke check 1	
- Stored stroke check 2, 3	
- Torque control	
- Unexpected disturbance torque detection function	
- Stroke limit check before move	

### OPERATION

- Automatic operation (memory)	
- Buffer register	
- DNC operation (Reader / puncher interface is required)	
- Dry run	
- Handle incremental feed	X1, X10, X100
- Manual Handle interruption	
- JOG feed	
- Manual handle feed	1 unit
- Manual intervention and return	
- Manual pulse generator	1 ea
- Manual reference position return	
- MDI operation	
- Program number search	
- Program restart	
- Sequence number search	
- Single block	
- Wrong operation prevention	
- Reference position shift	
- Reference position setting without dog	

### INTERPOLATION FUNCTIONS

- Nano interpolation	
- 1st. reference position return	Manual, G28
- 2nd. reference position return	G30
- 3rd/4th. reference position return	G30
- Circular interpolation	G02
- Continuous threading	
- Dwell (per sec)	G04
- High speed skip	
- Linear interpolation	G01
- Multiple threading	
- Positioning	G00
- Reference position return check	G27
- Thread cutting / Synchronous cutting	
- Thread cutting retract	
- Torque limit skip	
- Variable lead threading	

### FEED FUNCTION

- Automatic acceleration / deceleration	
- Cutting feedrate clamp	
- Feed per minute	
- Feed per revolution	
- Feedrate override (10% unit)	0 - 200 %
- Jog feed override (10% unit)	0 - 2000 mm/min
- Manual per revolution feed	
- Override cancel	
- Rapid traverse override	F0, 25, 100 %
- Rapid traverse rate	
- Tangential speed constant control	

### AUXILIARY / SPINDLE SPEED FUNCTION

- Spindle orientation	
- Actual spindle speed output	
- Auxiliary function lock	
- Constant surface speed control	
- High speed M / S / T interface	
- M - code function	M3 digits
- Rigid tapping	
- S - code function	S4 / S5 digits
- Spindle serial output	S4 / S5 digits
- Spindle speed override	0 - 150 %
- Spindle Output switching	

### PROGRAM INPUT

- Absolute / incremental programming	
- Addition of custom macro common variables	
- Automatic coordinate system setting	
- Canned cycle for drilling / Turning	
- Canned cycle	
- Circular Interpolation by R programming	
- Control in / out	
- Coordinate system setting	G50
- Coordinate system shift	
- Custom macro	
- Decimal point programming	
- Pocket calculator type decimal point programming	
- Diameter / radius programming (X axis)	
- Direct drawing dimension programming	
- Direct of coordinate system shift	
- G code system A / B / C	
- Input unit 10 time multiply	
- Label skip	
- Manual absolute on and off	
- Maximum program dimension	± 9 digit
- Multiple repetitive canned cycle	G70 - G76
- Multiple repetitive canned cycle II	
- Optional block skip	1 piece
- Parity check	
- Pattern data input	
- Plane selection	G17, G18, G19
- Program number	O4 digit
- Program stop / end (M00, M01 / M02, M30)	
- Programmable data input	G10
- Sequence number	N5 digit
- SUB program call	10 folds nested
- Tape code : ISO / EIA auto recognition	EIA RS422 / ISO840
- Tape format for FANUC Series10 / 11	
- Work coordinate system	G52 - G59
- Interruption type custom macro	
- Work coordinate system preset	

### TOOL FUNCTION / TOOL COMPENSATION

- Automatic tool offset	
- Direct input of offset value measured	
- Direct input of offset value measured B	
- T - code function	T2 + 2 digits
- Tool geometry / wear compensation	
- Tool life management	
- Extended tool life management	
- Tool nose radius compensation	
- Tool offset	G43, G44, G49
- Tool offset 7 digits	
- Tool offset pairs	64 pairs
- Tool offset value counter input	

### EDITING OPERATION

- Back ground editing	
- Extended part program editing	
- Memory card edit & operation	
- Number of registered programs	400 ea
- Part program editing	
- Part program storage length	1280 (512kB) m
- Play back	
- Program protect	

### SETTING AND DISPLAY

- Actual cutting feedrate display	
- Alarm display	
- Alarm history display	

- Current position display	
- Directory display and punch for each group	
- Directory display of floppy cassette	
- Display of spindle speed and T code at all screens	
- External message display	
- Help function	
- Multi - language display	
- Operation history display	
- Parameter setting and display	
- Program name display	31 characters
- Run hours / parts count display	
- Self-diagnosis function	
- Servo setting screen	
- Spindle setting screen	
- Status display	
- Operating monitor screen	
- Soft operator's panel	
- Tool path graphic display	

### DATA INPUT / OUTPUT

- External data input	
- External key input	
- External program input	
- External program number search	
- External work number search	
- Memory card input / output	
- Reader / puncher interface	CH1.interface
- RS232C interface	
- Automatic data backup	

### OTHERS

- Cycle start and lamp	
- Display unit	8.4" Color LCD
- Feed hold and lamp	
- NC and servo ready	
- PCMCIA port in the front of LCD display unit	
- PMC system0iD	
- Reset / rewind	

### OPERATION GUIDANCE FUNCTION

- Manual Guide Oi	
-------------------	--

### INTERFACE FUNCTION

- Ethernet function	Embedded ethernet
---------------------	-------------------

### OPTIONAL SPECIFICATIONS

#### AXIS CONTROL

- Controlled axes expansion (total)	Max.4 axes
- Simultaneous controlled axes expansion (total)	Max.4 axes

#### FEED FUNCTION

- Advanced preview control	
----------------------------	--

#### INTERFACE FUNCTION

- Fast ethernet / Data server	
-------------------------------	--

#### OPERATION

- Manual handle feed	2 units
----------------------	---------

#### OTHERS

- 10.4" Color TFT LCD	
- Ez guide I (only with 10.4" color TFT LCD option)	

#### ROBOT INTERFACE

- Robot interface with PMC I / O module	
(Hardware between PMC I / O modules)	
- Robot interface with PROFIBUS-DP	

Note : \*: Lynx 220M / LM

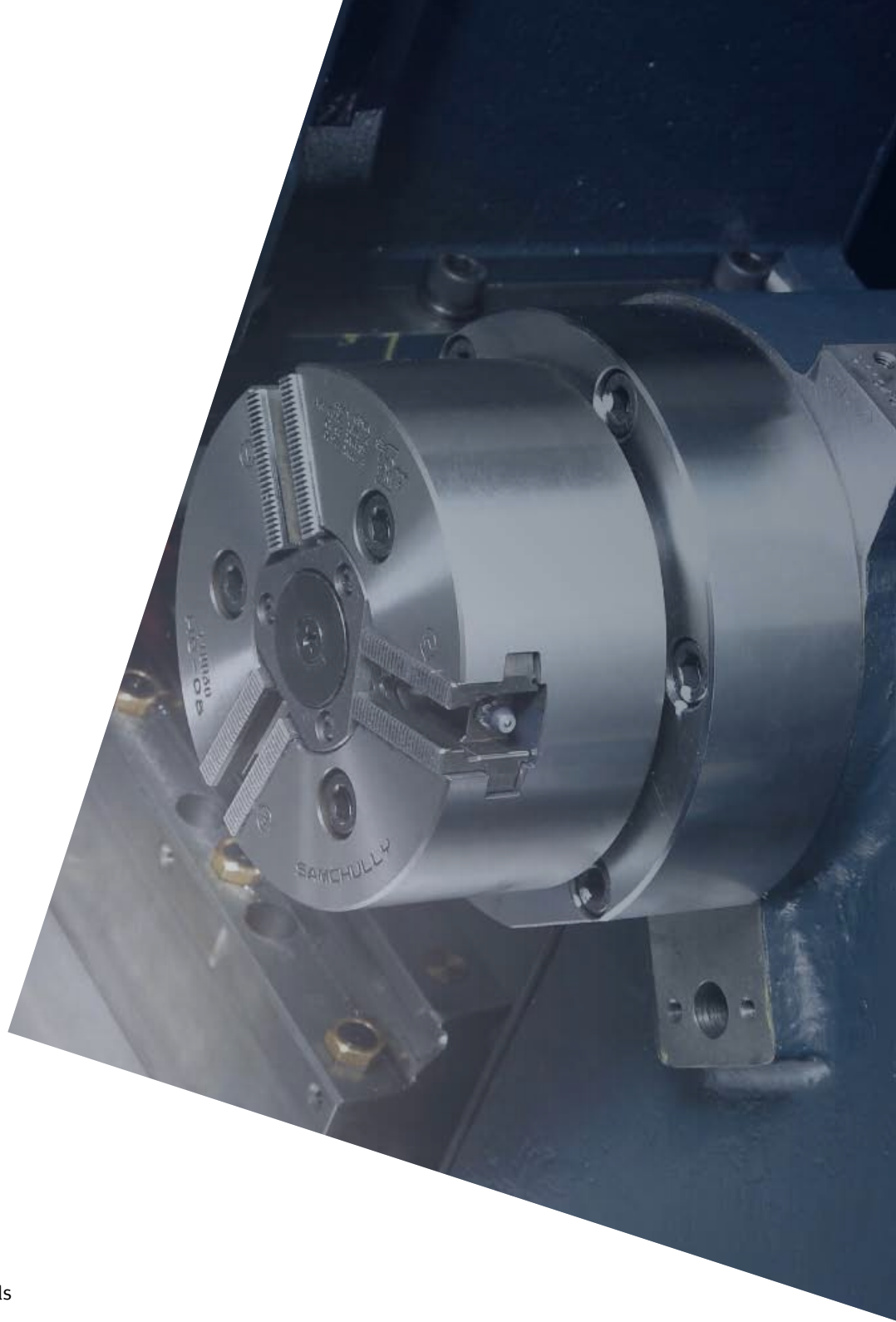

## Doosan Machine Tools

<http://www.doosanmachinetools.com>

[www.facebook.com/doosanmachinetools](https://www.facebook.com/doosanmachinetools)

### *Optimal Solutions for the Future*

#### **Head Office**

Yeonkang Bldg., 6th FL., 270, Yeonji-dong,  
Jongno-gu, Seoul, Korea  
Tel +82-2-3670-5345 / 5362  
Fax +82-2-3670-5382

#### **Doosan Machine Tools America**

19A Chapin Rd., Pine Brook, NJ 07058, U.S.A.  
Tel +1-973-618-2500  
Fax +1-973-618-2501

#### **Doosan Machine Tools China**

Room 101,201,301, Building 39 Xinzhuan Highway  
No.258 Songjiang District, China Shanghai(201612)  
Tel +86 21-5445-1155  
Fax +86 21-6405-1472

#### **Doosan Machine Tools Europe**

Emdener Strasse 24, D-41540 Dormagen, Germany  
Tel +49-2133-5067-100  
Fax +49-2133-5067-001

#### **Doosan Machine Tools Japan**

#2412, Mita Kokusai Bldg. 1-4-28 Mita,  
Minato-ku, Tokyo 108-0073, Japan  
Tel +81 3 5730 9013  
Fax +81 3 5730 9016

#### **Doosan Machine Tools India**

106 / 10-11-12, Amruthahalli, Byatarayanapura,  
Bellary road, Bangalore-560 092, India  
Tel +91-80-4266-0122 / 121 / 100



ver. EN 160502 SU

\* For more details, please contact Doosan Machine Tools.

\* The specifications and information above-mentioned may be changed without prior notice.

\* Doosan Machine Tools Co., Ltd. is a subsidiary of MBK Partners, a Korean private equity firm. The trademark  DOOSAN is used under a licensing agreement with Doosan Corporation, the registered trademark holder.